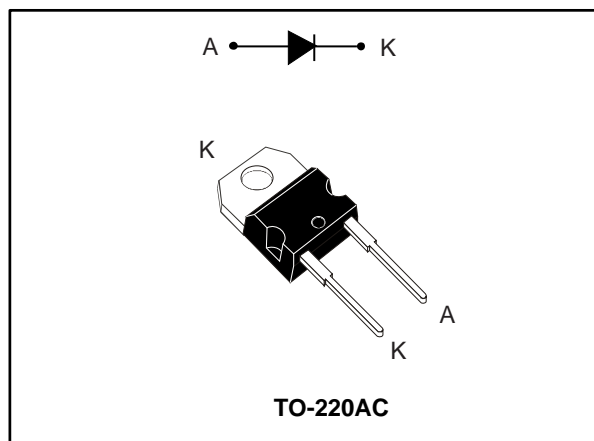

Automotive 650 V power Schottky silicon carbide diode

Datasheet - production data

Description

The SiC diode is a high voltage power Schottky diode. It is manufactured using a silicon carbide substrate. The wide band gap material allows the design of a Schottky diode structure with a 650 V rating. Due to the Schottky construction, no recovery is shown at turn-off and ringing patterns are negligible. The minimal capacitive turn-off behavior is independent of temperature.

Used as a freewheeling or output rectification diode, this rectifier will enhance the performance and form factor of the targeted power supply or inverter.

Features

- No or negligible reverse recovery
- Switching behavior independent of temperature
- Dedicated to PFC applications
- High forward surge capability
- AEC-Q101 qualified
- PPAP capable
- Operating T_j from -40 °C to 175 °C
- ECOPACK® 2 compliant component

Table 1: Device summary

Symbol	Value
$I_{F(AV)}$	12 A
V_{RRM}	650 V
T_j (max.)	175 °C
V_F (typ.)	1.30 V

1 Characteristics

Table 2: Absolute ratings (limiting values at 25 °C, unless otherwise specified)

Symbol	Parameter		Value	Unit
V _{RRM}	Repetitive peak reverse voltage (T _j = -40 °C to +175 °C)		650	V
I _{F(RMS)}	Forward rms current		22	A
I _{F(AV)}	Average forward current	T _c = 145 °C, DC ⁽¹⁾	12	A
I _{FRM}	Repetitive peak forward current	T _c = 145 °C, T _j = 175 °C, δ = 0.1	53	A
I _{FSM}	Surge non repetitive forward current	t _p = 10 ms sinusoidal, T _c = 25 °C	50	A
		t _p = 10 ms sinusoidal, T _c = 125 °C	40	
		t _p = 10 μs square, T _c = 25 °C	220	
T _{stg}	Storage temperature range		-55 to +175	°C
T _j	Operating junction temperature ⁽²⁾		-40 to +175	°C

Notes:

⁽¹⁾Value based on R_{th(j-c)} max.

⁽²⁾(dP_{tot}/dT_j) < (1/R_{th(j-a)}) condition to avoid thermal runaway for a diode on its own heatsink.

Table 3: Thermal parameters

Symbol	Parameter	Value		Unit
		Typ.	Max.	
R _{th(j-c)}	Junction to case	0.85	1.25	°C/W

Table 4: Static electrical characteristics

Symbol	Parameter	Test conditions		Min.	Typ.	Max.	Unit
I _R ⁽¹⁾	Reverse leakage current	T _j = 25 °C	V _R = V _{RRM}	-	15	150	μA
		T _j = 150 °C		-	200	1000	
		T _j = 25 °C	V _R = 600 V	-	8	50	
V _F ⁽²⁾	Forward voltage drop	T _j = 25 °C	I _F = 12 A	-	1.30	1.45	V
		T _j = 150 °C		-	1.45	1.65	
		T _j = 175 °C		-	1.50		

Notes:

⁽¹⁾Pulse test: t_p = 5 ms, δ < 2%

⁽²⁾Pulse test: t_p = 500 μs, δ < 2%

To evaluate the conduction losses use the following equation:

$$P = 1.02 \times I_{F(AV)} + 0.065 \times I_{F(RMS)}^2$$

Table 5: Dynamic electrical characteristics

Symbol	Parameter	Test conditions	Min.	Typ.	Max.	Unit
$Q_{Cj}^{(1)}$	Total capacitive charge	$V_R = 400 \text{ V}$	-	36	-	nC
C_j	Total capacitance	$V_R = 0 \text{ V}, T_c = 25 \text{ }^\circ\text{C}, F = 1 \text{ MHz}$	-	750	-	pF
		$V_R = 400 \text{ V}, T_c = 25 \text{ }^\circ\text{C}, F = 1 \text{ MHz}$	-	60	-	

Notes:

⁽¹⁾Most accurate value for the capacitive charge: $Q_{Cj} = \int_0^{V_{OUT}} C_j(V_R) \cdot dV_R$

1.1 Characteristics (curves)

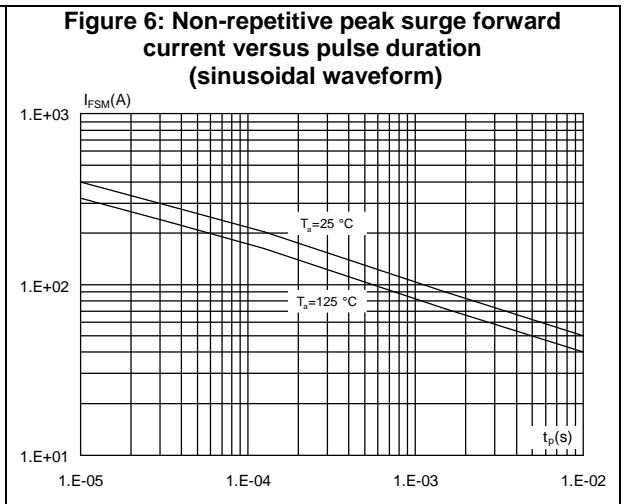
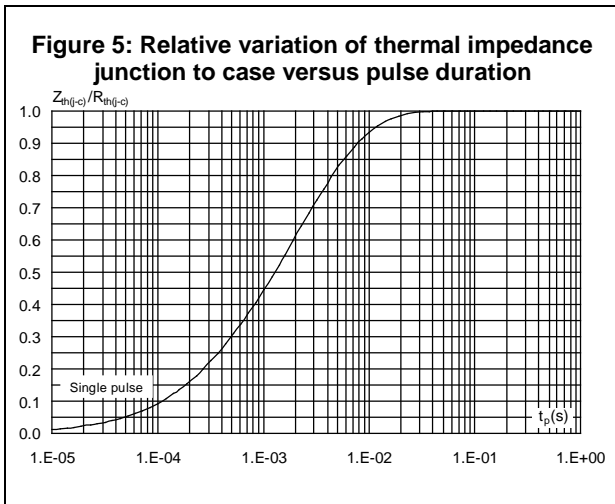
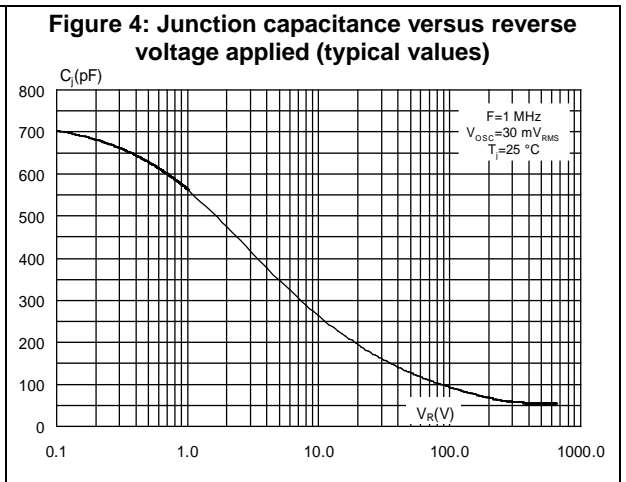
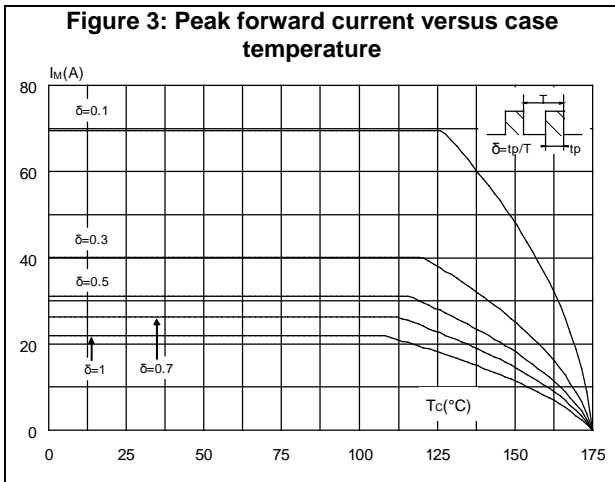
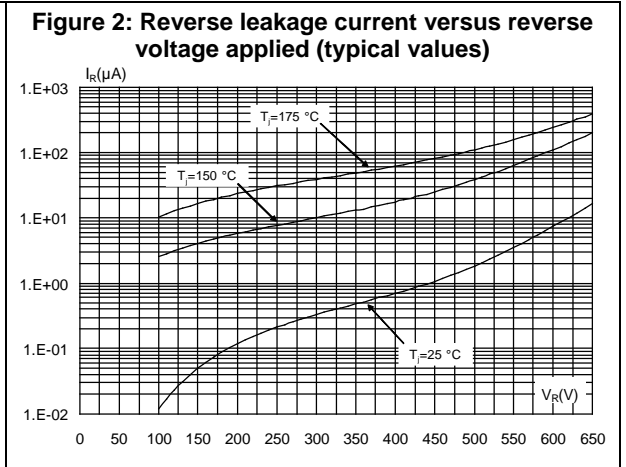
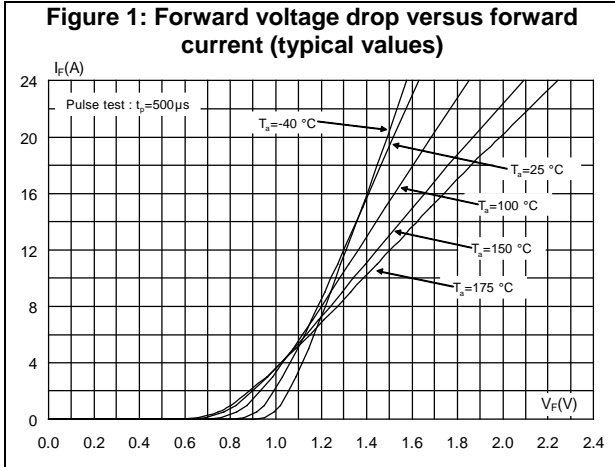
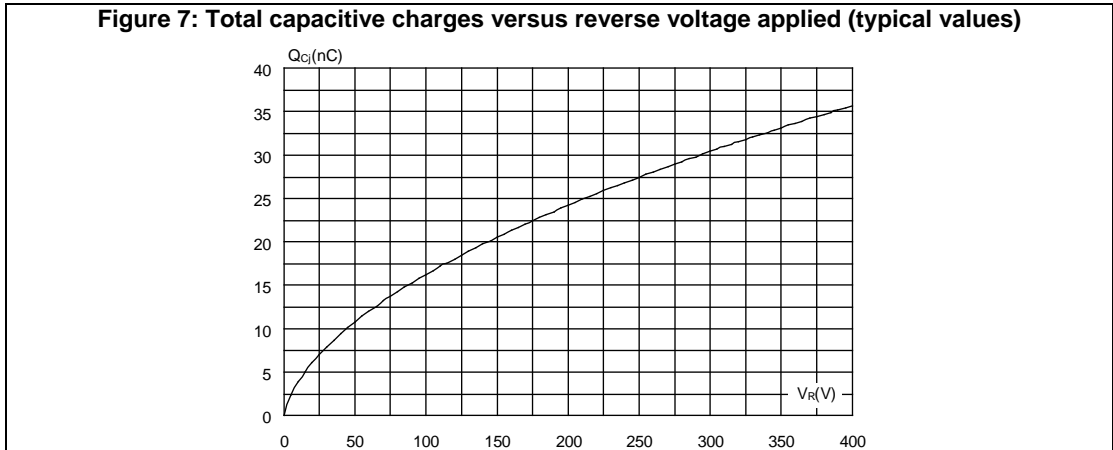

Figure 7: Total capacitive charges versus reverse voltage applied (typical values)



2 Package information

In order to meet environmental requirements, ST offers these devices in different grades of ECOPACK® packages, depending on their level of environmental compliance. ECOPACK® specifications, grade definitions and product status are available at: www.st.com. ECOPACK® is an ST trademark.

- Epoxy meets UL94, V0
- Cooling method: by conduction (C)
- Recommended torque value: 0.55 N·m
- Maximum torque value: 0.7 N·m

2.1 TO-220AC package information

Figure 8: TO-220AC package outline

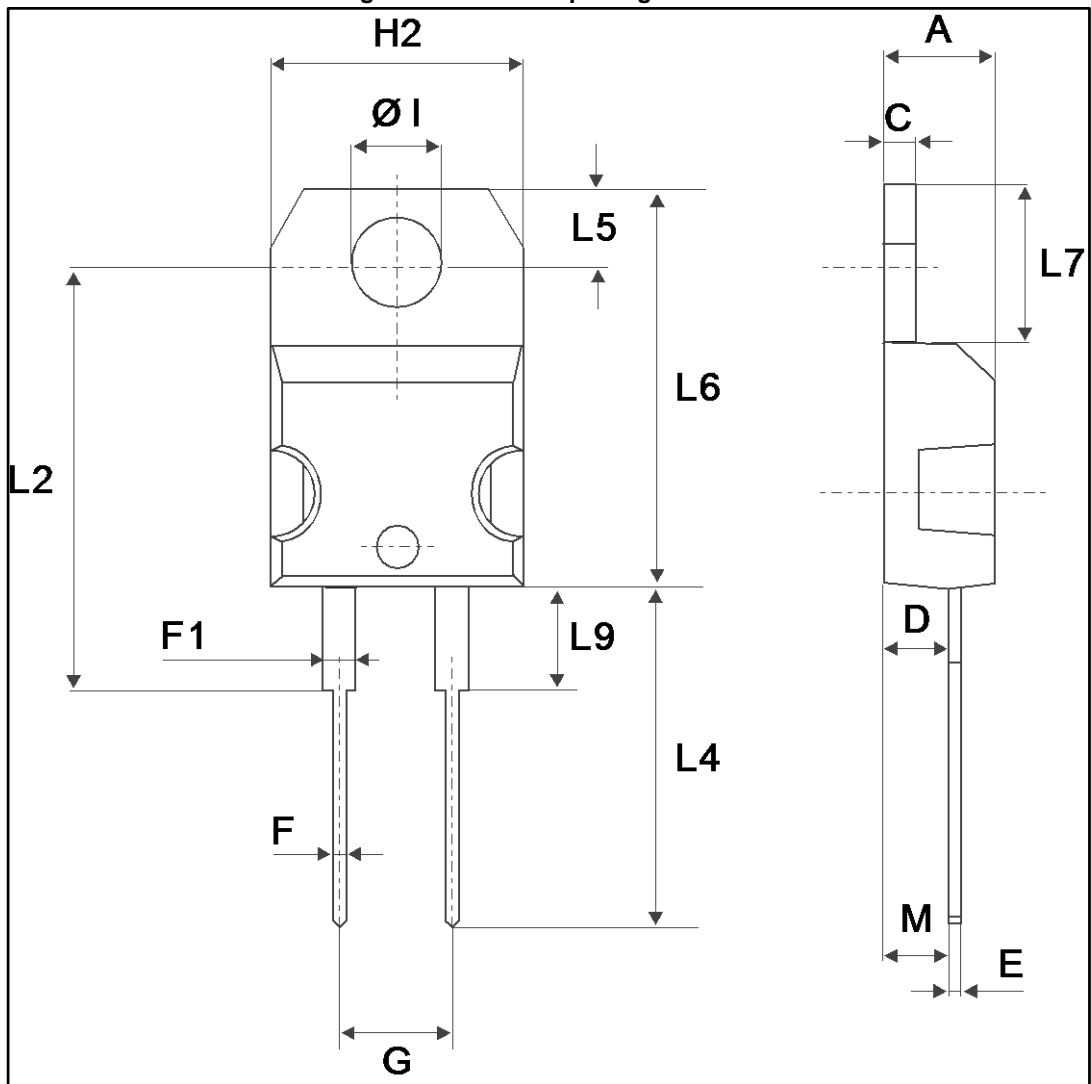

Table 6: TO-220AC package mechanical data

Ref.	Dimensions			
	Millimeters		Inches	
	Min.	Max.	Min.	Max.
A	4.40	4.60	0.173	0.181
C	1.23	1.32	0.048	0.051
D	2.40	2.72	0.094	0.107
E	0.49	0.70	0.019	0.027
F	0.61	0.88	0.024	0.034
F1	1.14	1.70	0.044	0.066
G	4.95	5.15	0.194	0.202
H2	10.00	10.40	0.393	0.409
L2	16.40 typ.		0.645 typ.	
L4	13.00	14.00	0.511	0.551
L5	2.65	2.95	0.104	0.116
L6	15.25	15.75	0.600	0.620
L7	6.20	6.60	0.244	0.259
L9	3.50	3.93	0.137	0.154
M	2.6 typ.		0.102 typ.	
Diam	3.75	3.85	0.147	0.151

3 Ordering information

Table 7: Ordering information

Order code	Marking	Package	Weight	Base qty.	Delivery mode
STPSC12065DY	PSC12065DY	TO-220AC	1.86 g	50	Tube

4 Revision history

Table 8: Document revision history

Date	Revision	Changes
10-May-2016	1	First issue.

IMPORTANT NOTICE – PLEASE READ CAREFULLY

STMicroelectronics NV and its subsidiaries ("ST") reserve the right to make changes, corrections, enhancements, modifications, and improvements to ST products and/or to this document at any time without notice. Purchasers should obtain the latest relevant information on ST products before placing orders. ST products are sold pursuant to ST's terms and conditions of sale in place at the time of order acknowledgement.

Purchasers are solely responsible for the choice, selection, and use of ST products and ST assumes no liability for application assistance or the design of Purchasers' products.

No license, express or implied, to any intellectual property right is granted by ST herein.

Resale of ST products with provisions different from the information set forth herein shall void any warranty granted by ST for such product.

ST and the ST logo are trademarks of ST. All other product or service names are the property of their respective owners.

Information in this document supersedes and replaces information previously supplied in any prior versions of this document.

© 2016 STMicroelectronics – All rights reserved

Mouser Electronics

Authorized Distributor

Click to View Pricing, Inventory, Delivery & Lifecycle Information:

[STMicroelectronics:](#)

[STPSC12065DY](#)