

Rail-to-rail 1.8 V high-speed dual comparator

Features

- Propagation delay: 38 ns
- Low current consumption: 73 μ A/Comp
- Rail-to-rail inputs
- Push-pull outputs
- Supply operation from 1.8 to 5 V
- Wide temperature range: -40° C to +125° C
- ESD tolerance: 5 kV HBM / 300 V MM
- Latch-up immunity: 200 mA
- SMD packages

Applications

- Telecommunications
- Instrumentation
- Signal conditioning
- High-speed sampling systems
- Portable communication systems

Description

The TS3022 dual comparator features a high-speed response time with rail-to-rail inputs. With a supply voltage specified from 2 to 5 V, this comparator can operate over a wide temperature range: -40° C to +125° C.

The TS3022 comparator offers micropower consumption as low as a few tens of microamperes thus providing an excellent ratio of power consumption current versus response time.

The TS3022 includes push-pull outputs and is available in small packages (SMD): SO-8 and MiniSO-8.

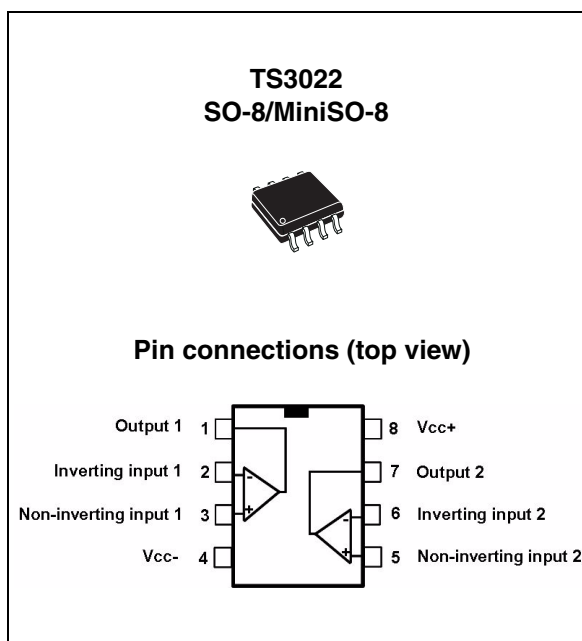

1 Absolute maximum ratings and operating conditions

Table 1. Absolute maximum ratings

Symbol	Parameter	Value	Unit
V _{CC}	Supply voltage ⁽¹⁾	5.5	V
V _{ID}	Differential input voltage ⁽²⁾	±5	V
V _{IN}	Input voltage range	(V _{CC-}) - 0.3 to (V _{CC+}) + 0.3	V
R _{THJA}	Thermal resistance junction to ambient ⁽³⁾ SO-8 MiniSO-8	125 190	°C/W
R _{THJC}	Thermal resistance junction to case ⁽³⁾ SO-8 MiniSO-8	40 39	°C/W
T _{STG}	Storage temperature	-65 to +150	°C
T _J	Junction temperature	150	°C
T _{LEAD}	Lead temperature (soldering 10 seconds)	260	°C
ESD	Human body model (HBM) ⁽⁴⁾	5000	V
	Machine model (MM) ⁽⁵⁾	300	
	Charged device model (CDM) ⁽⁶⁾	1500	
	Latch-up immunity	200	mA

1. All voltage values, except differential voltage, are referenced to V_{CC-}. V_{CC} is defined as the difference between V_{CC+} and V_{CC-}.
2. The magnitude of input and output voltages must never exceed the supply rail ±0.3V.
3. Short-circuits can cause excessive heating. These values are typical.
4. Human body model: a 100 pF capacitor is charged to the specified voltage, then discharged through a 1.5 kΩ resistor between two pins of the device. This is done for all couples of connected pin combinations while the other pins are floating.
5. Machine model: a 200 pF capacitor is charged to the specified voltage, then discharged directly between two pins of the device with no external series resistor (internal resistor < 5 Ω). This is done for all couples of connected pin combinations while the other pins are floating.
6. Charged device model: all pins and the package are charged together to the specified voltage and then discharged directly to the ground through only one pin. This is done for all pins.

Table 2. Operating conditions

Symbol	Parameter	Value	Unit
T _{oper}	Operating temperature range	-40 to +125	°C
V _{CC}	Supply voltage 0° C < T _{amb} < +125° C -40° C < T _{amb} < +125° C	1.8 to 5 2 to 5	V
V _{ICM}	Common mode input voltage range -40° C < T _{amb} < +85° C +85° C < T _{amb} < +125° C	(V _{CC-})-0.2 to (V _{CC+})+0.2 V _{CC-} to V _{CC+}	V

2 Electrical characteristics

Table 3. $V_{CC+} = 2\text{ V}$, $V_{CC-} = 0\text{ V}$, $T_{amb} = +25^\circ\text{ C}$, full V_{ICM} range (unless otherwise specified)⁽¹⁾

Symbol	Parameter	Test conditions	Min.	Typ.	Max.	Unit
V_{IO}	Input offset voltage	$-40^\circ\text{ C} < T_{amb} < +125^\circ\text{ C}$	-	0.5	6 7	mV
ΔV_{IO}	Input offset voltage drift	$-40^\circ\text{ C} < T_{amb} < +125^\circ\text{ C}$	-	3	20	$\mu\text{V}/^\circ\text{C}$
I_{IO}	Input offset current ⁽²⁾	$-40^\circ\text{ C} < T_{amb} < +125^\circ\text{ C}$	-	1	20 100	nA
I_{IB}	Input bias current ⁽²⁾	$-40^\circ\text{ C} < T_{amb} < +125^\circ\text{ C}$	-	86	160 300	nA
I_{CC}	Supply current/comp.	No load, output high, $V_{ICM} = 0\text{ V}$ $-40^\circ\text{ C} < T_{amb} < +125^\circ\text{ C}$ No load, output low, $V_{ICM} = 0\text{ V}$ $-40^\circ\text{ C} < T_{amb} < +125^\circ\text{ C}$	-	73 84	90 115 105 125	μA
I_{SC}	Short-circuit current	Source Sink	-	9 10	-	mA
V_{OH}	Output voltage high	$I_{Source} = 1\text{ mA}$ $-40^\circ\text{ C} < T_{amb} < +125^\circ\text{ C}$	1.88 1.80	1.92	-	V
V_{OL}	Output voltage low	$I_{Sink} = 1\text{ mA}$ $-40^\circ\text{ C} < T_{amb} < +125^\circ\text{ C}$	-	60	100 150	mV
CMRR	Common mode rejection ratio	$0 < V_{ICM} < 2\text{ V}$	-	67	-	dB
SVR	Supply voltage rejection	$\Delta V_{CC} = 2\text{ to }5\text{ V}$	58	73	-	dB
TP_{LH}	Propagation delay ⁽³⁾ Low to high output level	$V_{ICM} = 0\text{ V}$, $f = 10\text{ kHz}$, $C_L = 50\text{ pF}$, Overdrive = 100 mV Overdrive = 20 mV	-	38 48	60 75	ns
TP_{HL}	Propagation delay ⁽⁴⁾ High to low output level	$V_{ICM} = 0\text{ V}$, $f = 10\text{ kHz}$, $C_L = 50\text{ pF}$, Overdrive = 100 mV Overdrive = 20 mV	-	40 49	60 75	ns
T_F	Fall time	$f = 10\text{ kHz}$, $C_L = 50\text{ pF}$, $R_L = 10\text{ k}\Omega$, Overdrive = 100 mV	-	8	-	ns
T_R	Rise time	$f = 10\text{ kHz}$, $C_L = 50\text{ pF}$, $R_L = 10\text{ k}\Omega$, Overdrive = 100 mV	-	9	-	ns

1. All values over the temperature range are guaranteed through correlation and simulation. No production test is performed at the temperature range limits.
2. Maximum values include unavoidable inaccuracies of the industrial tests.
3. Response time is measured at 50% of final output value with following conditions: inverting input voltage (IN-) = V_{ICM} and non-inverting input voltage (IN+) moving from $V_{ICM} - 100\text{ mV}$ to $V_{ICM} + \text{overdrive}$.
4. Response time is measured at 50% of final output value with following conditions: inverting input voltage (IN-) = V_{ICM} and non-inverting input voltage (IN+) moving from $V_{ICM} + 100\text{ mV}$ to $V_{ICM} - \text{overdrive}$.

Table 4. $V_{CC+} = 3.3\text{ V}$, $V_{CC-} = 0\text{ V}$, $T_{amb} = +25^\circ\text{ C}$, full V_{ICM} range (unless otherwise specified)⁽¹⁾

Symbol	Parameter	Test conditions	Min.	Typ.	Max.	Unit
V_{IO}	Input offset voltage	$-40^\circ\text{ C} < T_{amb} < +125^\circ\text{ C}$	-	0.2	6 7	mV
ΔV_{IO}	Input offset voltage drift	$-40^\circ\text{ C} < T_{amb} < +125^\circ\text{ C}$	-	3	20	$\mu\text{V}/^\circ\text{C}$
I_{IO}	Input offset current ⁽²⁾	$-40^\circ\text{ C} < T_{amb} < +125^\circ\text{ C}$	-	1	20 100	nA
I_{IB}	Input bias current ⁽²⁾	$-40^\circ\text{ C} < T_{amb} < +125^\circ\text{ C}$	-	86	160 300	nA
I_{CC}	Supply current / Comp.	No load, output high, $V_{ICM} = 0\text{ V}$ $-40^\circ\text{ C} < T_{amb} < +125^\circ\text{ C}$	-	75	90 120	μA
		No load, output low, $V_{ICM} = 0\text{ V}$ $-40^\circ\text{ C} < T_{amb} < +125^\circ\text{ C}$		86	110 125	
I_{SC}	Short circuit current	Source Sink	-	26 24	-	mA
V_{OH}	Output voltage high	$I_{Source} = 1\text{ mA}$ $-40^\circ\text{ C} < T_{amb} < +125^\circ\text{ C}$	3.20 3.10	3.25	-	V
V_{OL}	Output voltage low	$I_{Sink} = 1\text{ mA}$ $-40^\circ\text{ C} < T_{amb} < +125^\circ\text{ C}$	-	40	80 150	mV
CMRR	Common mode rejection ratio	$0 < V_{ICM} < 3.3\text{ V}$	-	75	-	dB
SVR	Supply voltage rejection	$\Delta V_{CC} = 2\text{ to }5\text{ V}$	58	73	-	dB
TP_{LH}	Propagation delay ⁽³⁾ Low to high output level	$V_{ICM} = 0\text{ V}$, $f = 10\text{ kHz}$, $C_L = 50\text{ pF}$, Overdrive = 100 mV Overdrive = 20 mV	-	39	65 85	ns
				50		
TP_{HL}	Propagation delay ⁽⁴⁾ High to low output level	$V_{ICM} = 0\text{ V}$, $f = 10\text{ kHz}$, $C_L = 50\text{ pF}$, Overdrive = 100 mV Overdrive = 20 mV	-	41	65 80	ns
				51		
T_F	Fall time	$f = 10\text{ kHz}$, $C_L = 50\text{ pF}$, $R_L = 10\text{ k}\Omega$, Overdrive = 100 mV	-	5	-	ns
T_R	Rise time	$f = 10\text{ kHz}$, $C_L = 50\text{ pF}$, $R_L = 10\text{ k}\Omega$, Overdrive = 100 mV	-	7	-	ns

1. All values over the temperature range are guaranteed through correlation and simulation. No production test is performed at the temperature range limits.
2. Maximum values include unavoidable inaccuracies of the industrial tests.
3. Response time is measured at 50% of final output value with following conditions: inverting input voltage (IN-) = V_{ICM} and non-inverting input voltage (IN+) moving from $V_{ICM} - 100\text{ mV}$ to $V_{ICM} + \text{overdrive}$.
4. Response time is measured at 50% of final output value with following conditions: inverting input voltage (IN-) = V_{ICM} and non-inverting input voltage (IN+) moving from $V_{ICM} + 100\text{ mV}$ to $V_{ICM} - \text{overdrive}$.

Table 5. $V_{CC+} = 5\text{ V}$, $V_{CC-} = 0\text{ V}$, $T_{amb} = +25^\circ\text{ C}$, full V_{ICM} range (unless otherwise specified)⁽¹⁾

Symbol	Parameter	Test conditions	Min.	Typ.	Max.	Unit
V_{IO}	Input offset voltage	$-40^\circ\text{ C} < T_{amb} < +125^\circ\text{ C}$	-	0.2	6 7	mV
ΔV_{IO}	Input offset voltage drift	$-40^\circ\text{ C} < T_{amb} < +125^\circ\text{ C}$	-	3	20	$\mu\text{V}/^\circ\text{C}$
I_{IO}	Input offset current ⁽²⁾	$-40^\circ\text{ C} < T_{amb} < +125^\circ\text{ C}$	-	1	20 100	nA
I_{IB}	Input bias current ⁽²⁾	$-40^\circ\text{ C} < T_{amb} < +125^\circ\text{ C}$	-	86	160 300	nA
I_{CC}	Supply current / Comp.	No load, output high, $V_{ICM} = 0\text{ V}$ $-40^\circ\text{ C} < T_{amb} < +125^\circ\text{ C}$	-	77	95 125	μA
		No load, output low, $V_{ICM} = 0\text{ V}$ $-40^\circ\text{ C} < T_{amb} < +125^\circ\text{ C}$	-	89	115 135	
I_{SC}	Short circuit current	Source		51	-	mA
		Sink		40		
V_{OH}	Output voltage high	$I_{Source} = 4\text{ mA}$ $-40^\circ\text{ C} < T_{amb} < +125^\circ\text{ C}$	4.80 4.70	4.84	-	V
V_{OL}	Output voltage low	$I_{Sink} = 4\text{ mA}$ $-40^\circ\text{ C} < T_{amb} < +125^\circ\text{ C}$	-	130	180 250	mV
CMRR	Common mode rejection ratio	$0 < V_{ICM} < 5\text{ V}$	-	79	-	dB
SVR	Supply voltage rejection	$\Delta V_{CC} = 2\text{ to }5\text{ V}$	58	73	-	dB
TP_{LH}	Propagation delay ⁽³⁾ Low to high output level	$V_{ICM} = 0\text{ V}$, $f = 10\text{ kHz}$, $C_L = 50\text{ pF}$, Overdrive = 100 mV Overdrive = 20 mV	-	42 54	75 105	ns
			-	45 55	75 95	
TP_{HL}	Propagation delay ⁽⁴⁾ High to low output level	$V_{ICM} = 0\text{ V}$, $f = 10\text{ kHz}$, $C_L = 50\text{ pF}$, Overdrive = 100 mV Overdrive = 20 mV	-	45 55	75 95	ns
			-	4	-	
T_F	Fall time	$f = 10\text{ kHz}$, $C_L = 50\text{ pF}$, $R_L = 10\text{ k}\Omega$, Overdrive = 100 mV	-	4	-	ns
T_R	Rise time	$f = 10\text{ kHz}$, $C_L = 50\text{ pF}$, $R_L = 10\text{ k}\Omega$, Overdrive = 100 mV	-	4	-	ns

1. All values over the temperature range are guaranteed through correlation and simulation. No production test is performed at the temperature range limits.
2. Maximum values include unavoidable inaccuracies of the industrial tests.
3. Response time is measured at 50% of final output value with following conditions: inverting input voltage (IN-) = V_{ICM} and non-inverting input voltage (IN+) moving from $V_{ICM} - 100\text{ mV}$ to $V_{ICM} + \text{overdrive}$.
4. Response time is measured at 50% of final output value with following conditions: inverting input voltage (IN-) = V_{ICM} and non-inverting input voltage (IN+) moving from $V_{ICM} + 100\text{ mV}$ to $V_{ICM} - \text{overdrive}$.

Figure 1. Current consumption /comp. vs. power supply voltage

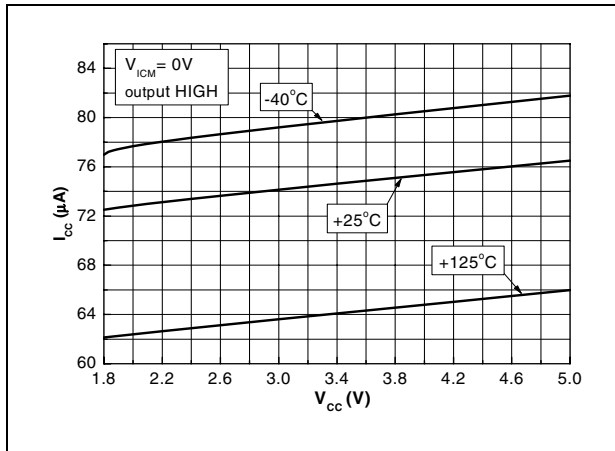

Figure 2. Current consumption /comp. vs. power supply voltage

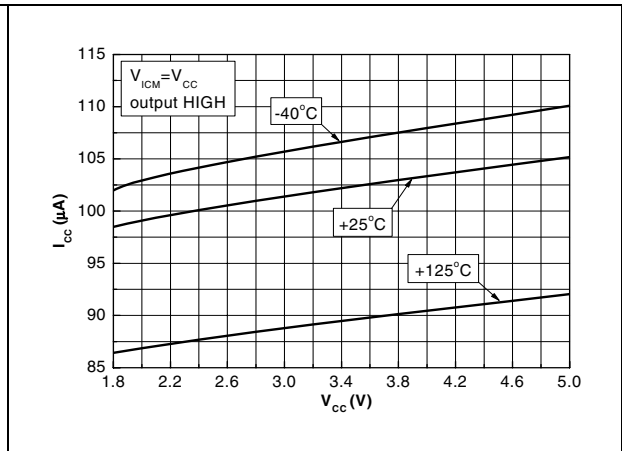

Figure 3. Current consumption /comp. vs. power supply voltage

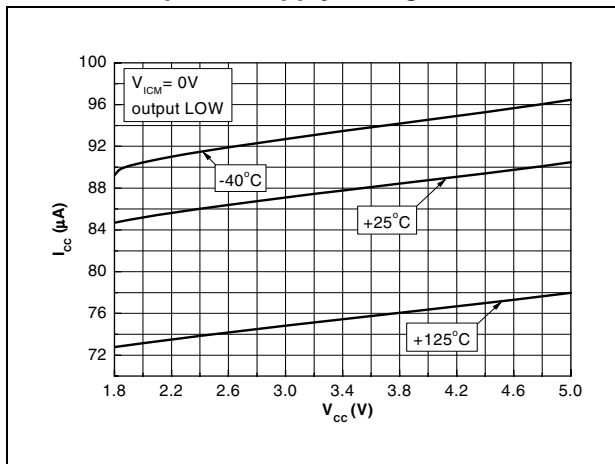

Figure 4. Current consumption /comp. vs. power supply voltage

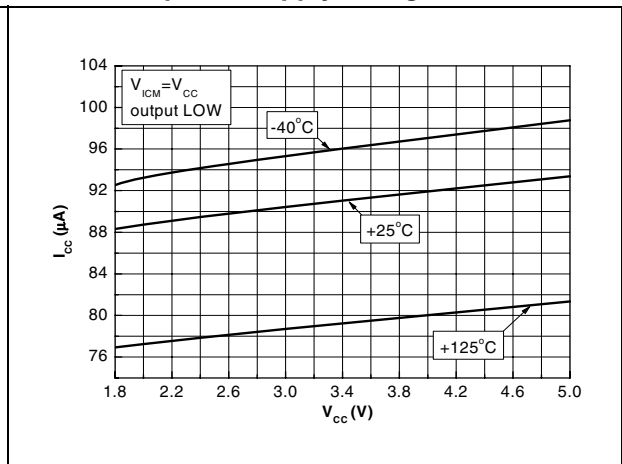

Figure 5. Output voltage vs. source current $V_{CC} = 2V$

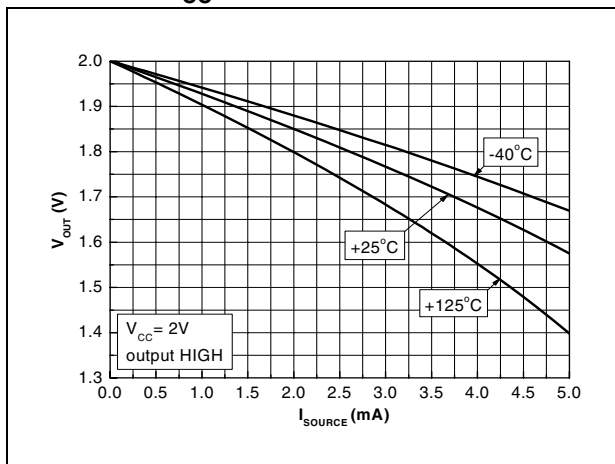

Figure 6. Output voltage vs. sink current $V_{CC} = 2V$

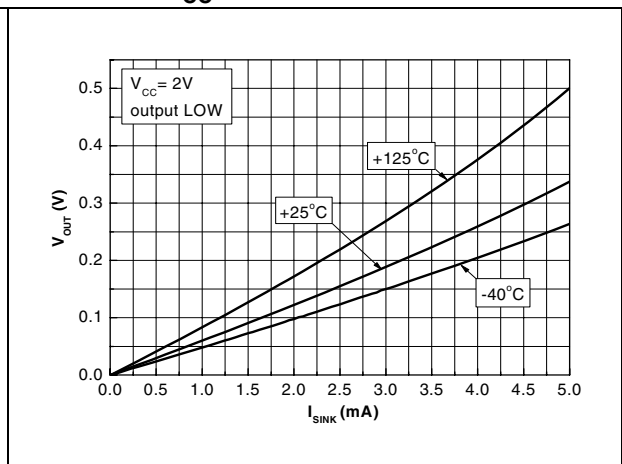

Figure 7. Output voltage vs. source current
 $V_{CC} = 3.3\text{ V}$

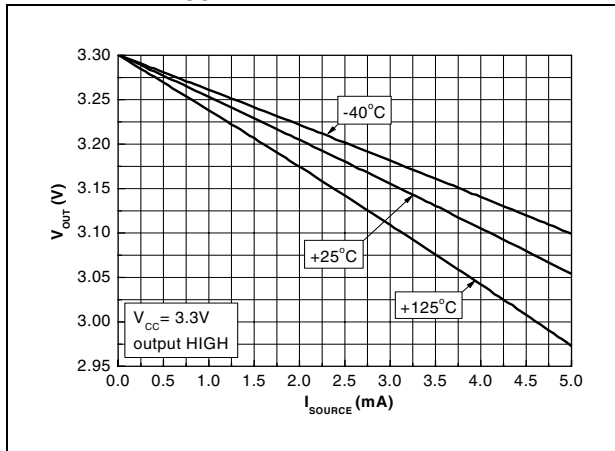

Figure 8. Output voltage vs. sink current
 $V_{CC} = 3.3\text{ V}$

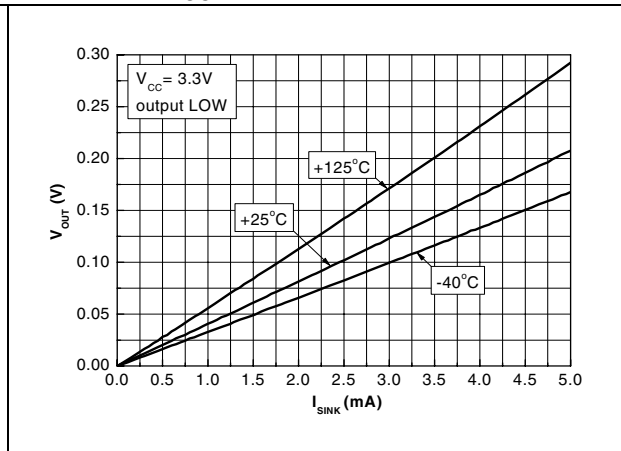

Figure 9. Output Voltage vs. source current
 $V_{CC} = 5\text{ V}$

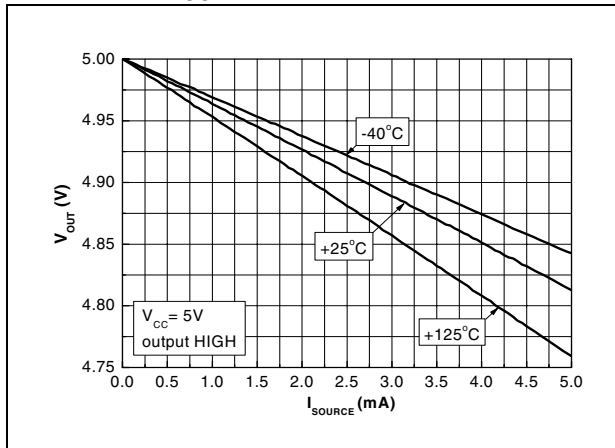

Figure 10. Output voltage vs. sink current
 $V_{CC} = 5\text{ V}$

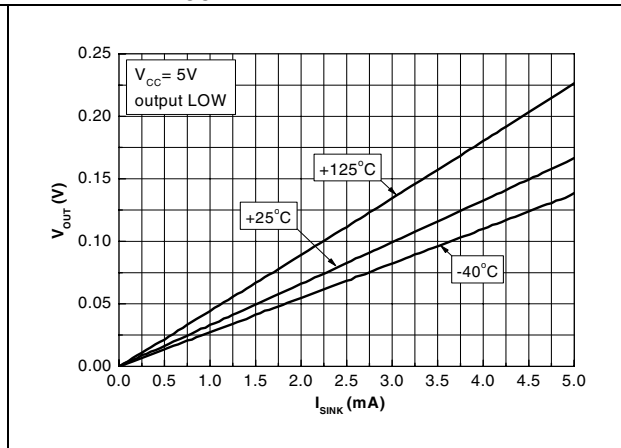

Figure 11. Input offset voltage vs. temperature

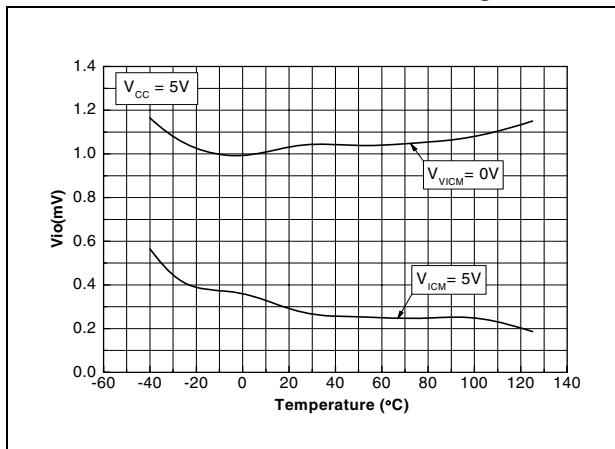

Figure 12. Input bias current vs. input voltage and temperature

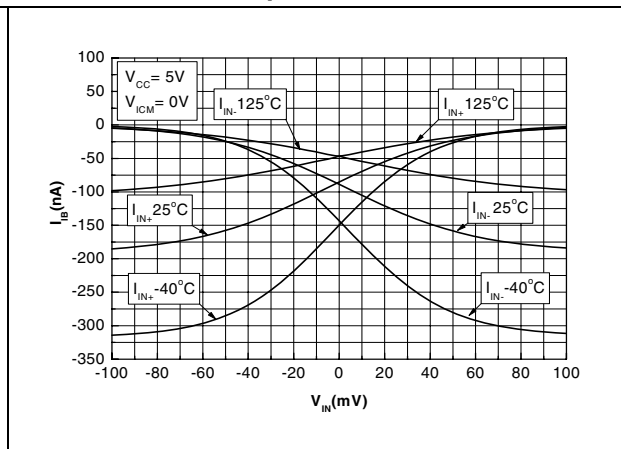

Figure 13. Current consumption vs. commutation frequency

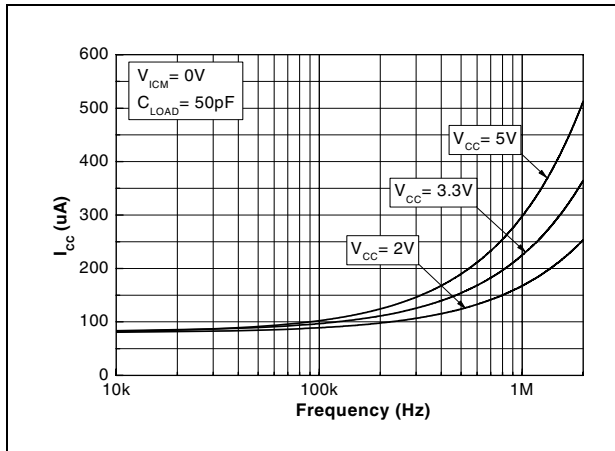

Figure 14. Propagation delay vs. overdrive $V_{CC} = 2V$

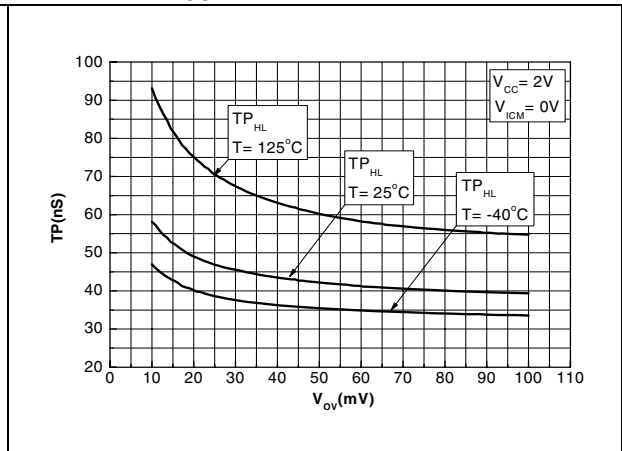

Figure 15. Propagation delay vs. overdrive $V_{CC} = 2V$

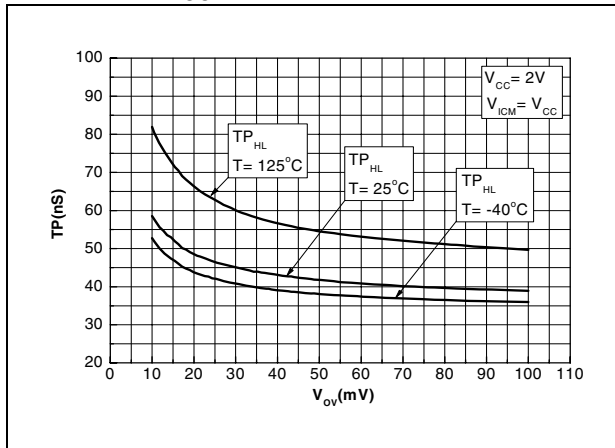

Figure 16. Propagation delay vs. overdrive $V_{CC} = 2V$

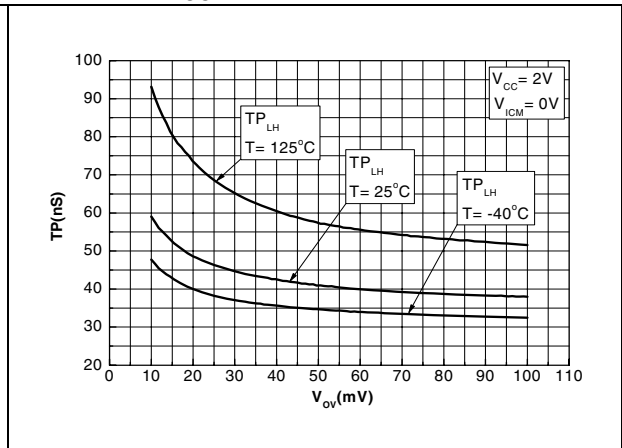

Figure 17. Propagation delay vs. overdrive $V_{CC} = 2V$

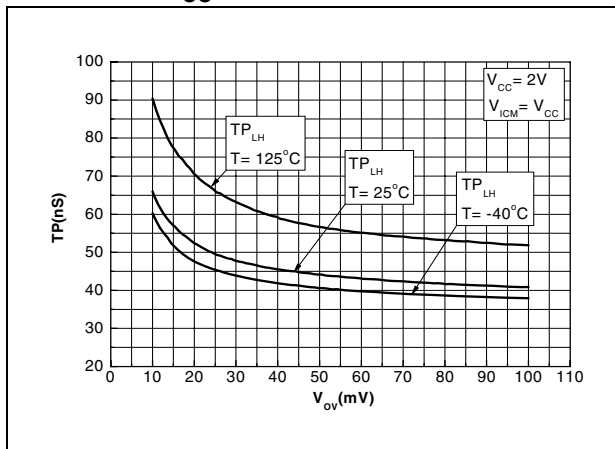

Figure 18. Propagation delay vs. overdrive $V_{CC} = 3.3V$

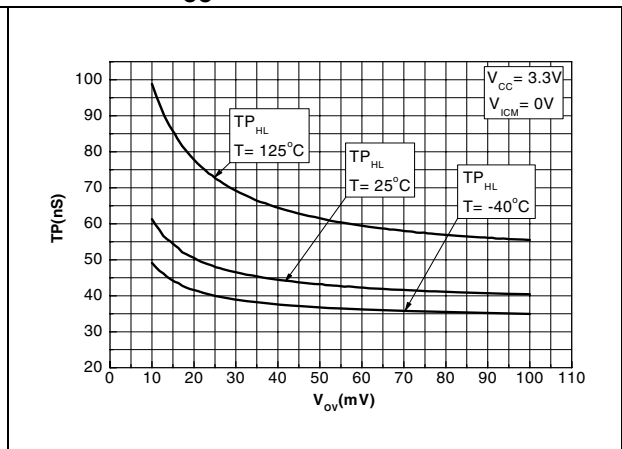

Figure 19. Propagation delay vs. overdrive
 $V_{CC} = 3.3\text{ V}$

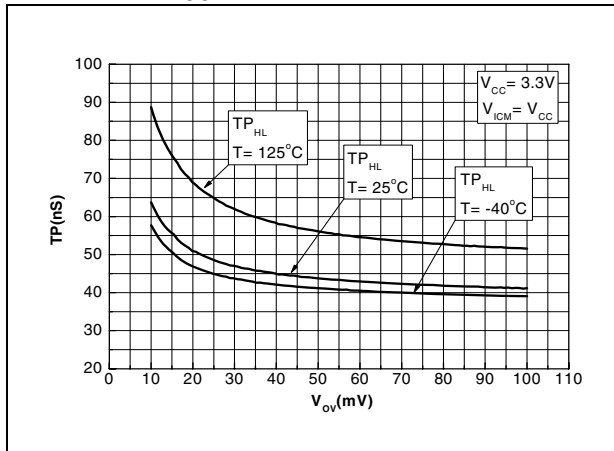

Figure 20. Propagation delay vs. overdrive
 $V_{CC} = 3.3\text{ V}$

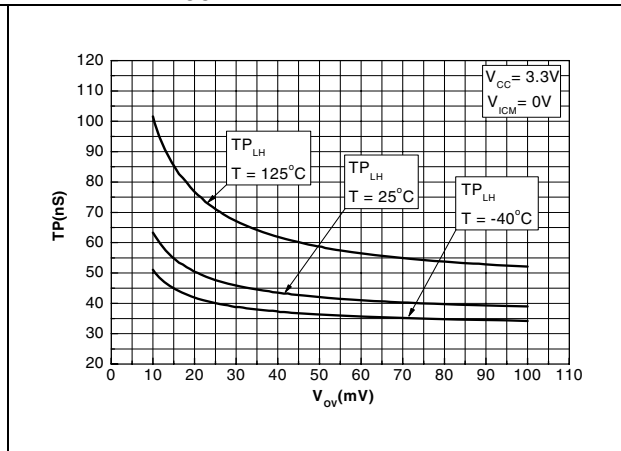

Figure 21. Propagation delay vs. overdrive
 $V_{CC} = 3.3\text{ V}$

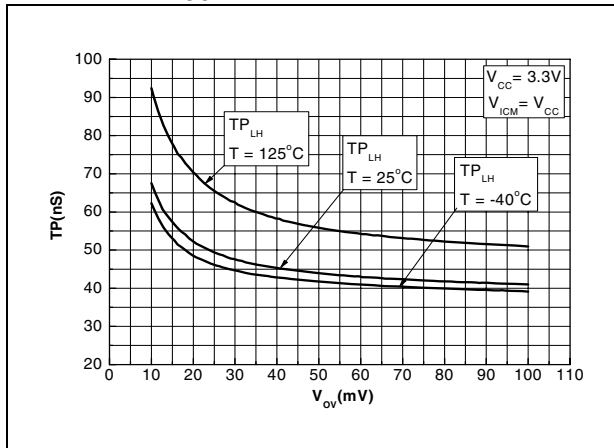

Figure 22. Propagation delay vs. overdrive
 $V_{CC} = 5\text{ V}$

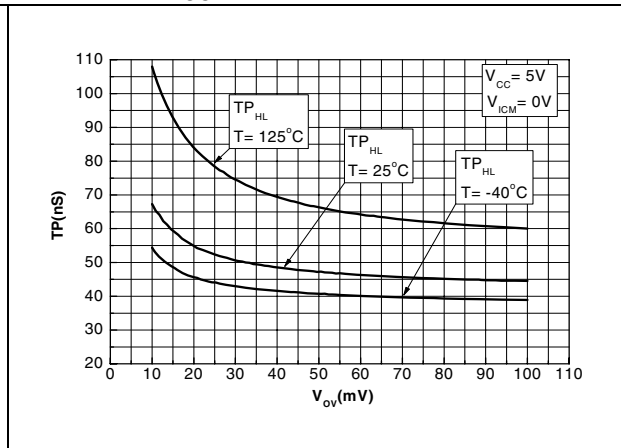

Figure 23. Propagation delay vs. overdrive
 $V_{CC} = 5\text{ V}$

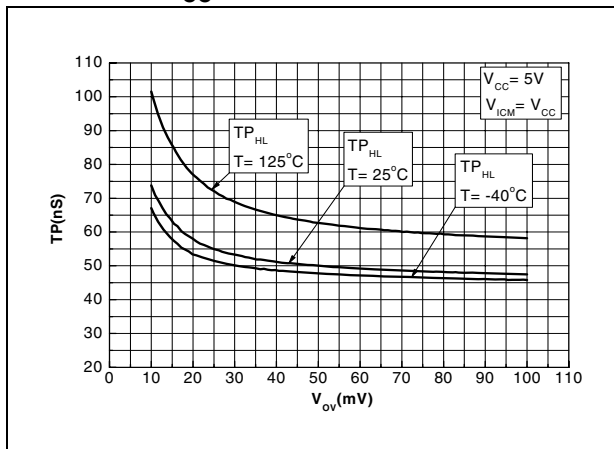

Figure 24. Propagation delay vs. overdrive
 $V_{CC} = 5\text{ V}$

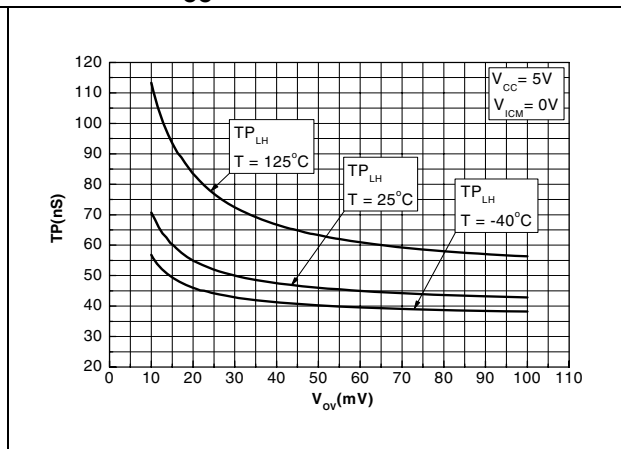

Figure 25. Propagation delay vs. overdrive
 $V_{CC} = 5\text{ V}$

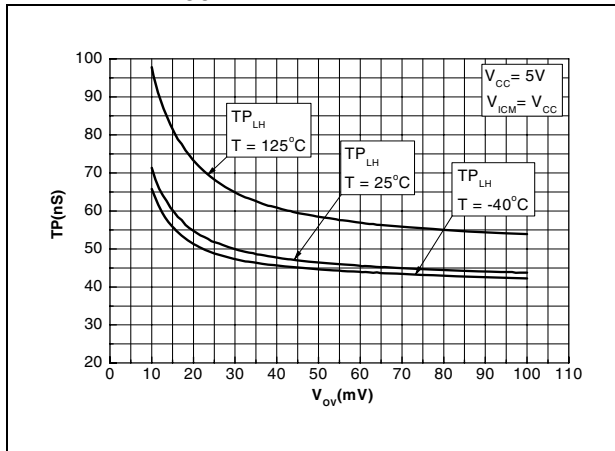

Figure 26. Propagation delay vs. temperature
 $V_{CC} = 5\text{ V}$, overdrive = 100 mV

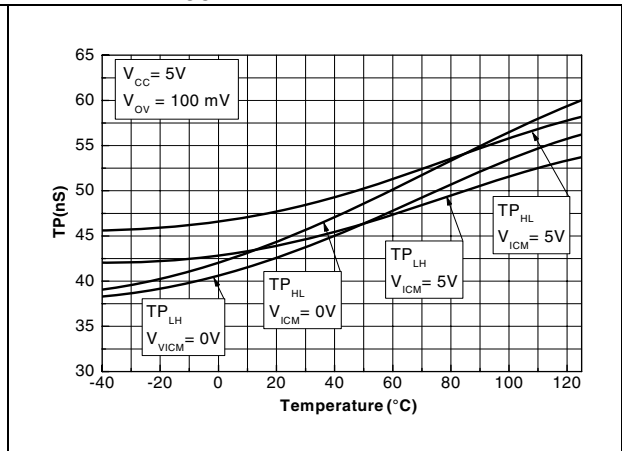
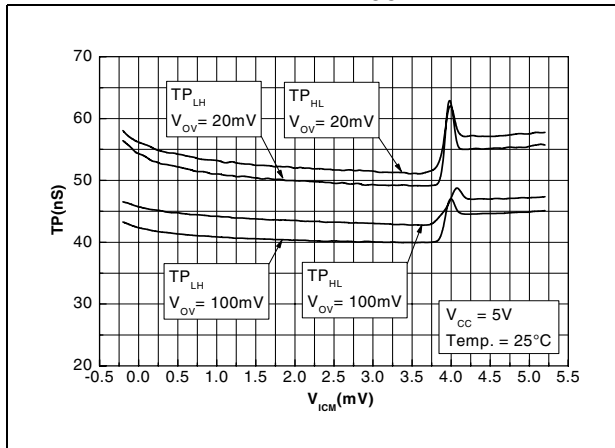

Figure 27. Propagation delay vs. common mode voltage, $V_{CC} = 5\text{ V}$



3 Package information

In order to meet environmental requirements, ST offers these devices in different grades of ECOPACK[®] packages, depending on their level of environmental compliance. ECOPACK[®] specifications, grade definitions and product status are available at: www.st.com. ECOPACK[®] is an ST trademark.

3.1 SO-8 package information

Figure 28. SO-8 package mechanical drawing

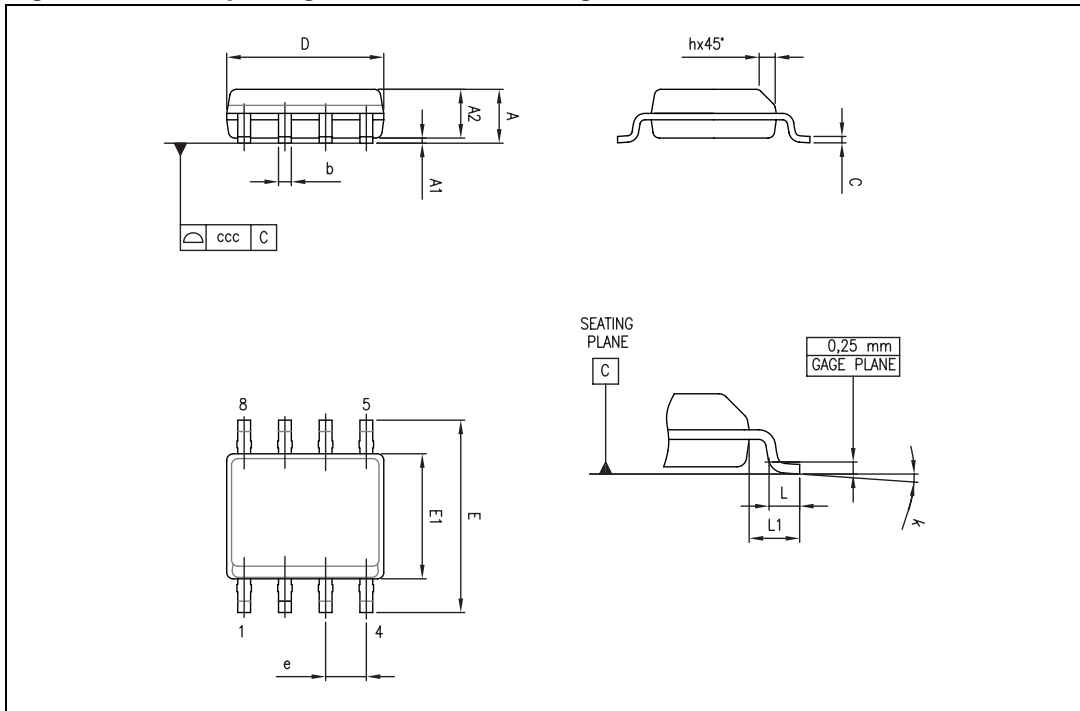

Table 6. SO-8 package mechanical data

Ref.	Dimensions					
	Millimeters			Inches		
	Min.	Typ.	Max.	Min.	Typ.	Max.
A			1.75			0.069
A1	0.10		0.25	0.004		0.010
A2	1.25			0.049		
b	0.28		0.48	0.011		0.019
c	0.17		0.23	0.007		0.010
D	4.80	4.90	5.00	0.189	0.193	0.197
E	5.80	6.00	6.20	0.228	0.236	0.244
E1	3.80	3.90	4.00	0.150	0.154	0.157
e		1.27			0.050	
h	0.25		0.50	0.010		0.020
L	0.40		1.27	0.016		0.050
L1		1.04			0.040	
k	0		8°	1°		8°
ccc			0.10			0.004

3.2 MiniSO-8 package information

Figure 29. MiniSO-8 package mechanical drawing

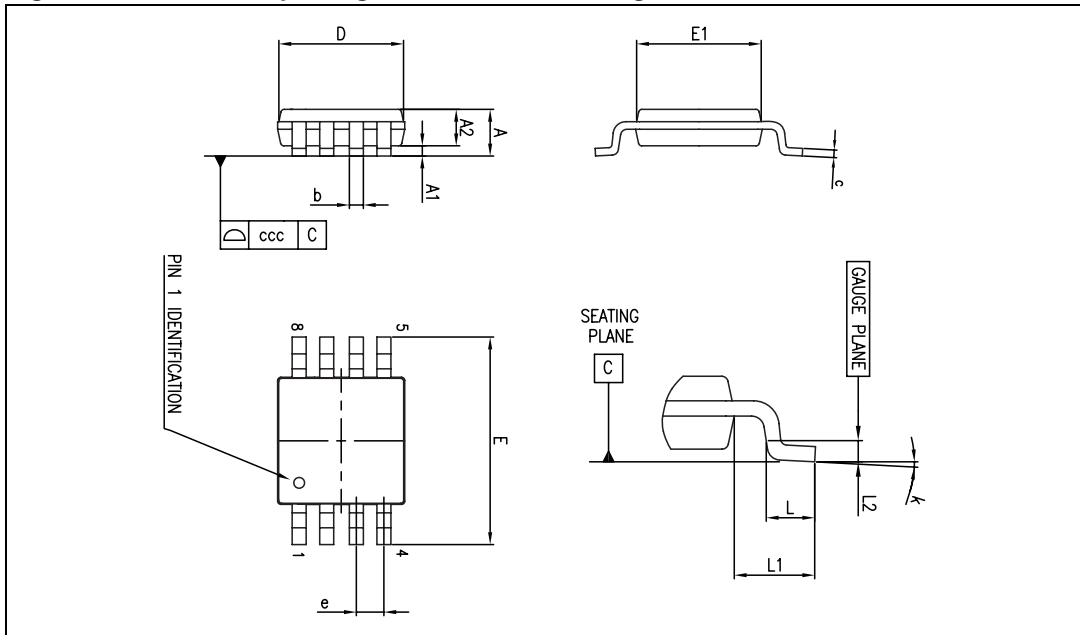

Table 7. MiniSO-8 package mechanical data

Ref.	Dimensions					
	Millimeters			Inches		
	Min.	Typ.	Max.	Min.	Typ.	Max.
A			1.10			0.043
A1			0.15			0.006
A2	0.75	0.85	0.95	0.030	0.033	0.037
b	0.22		0.40	0.009		0.016
c	0.08		0.23	0.003		0.009
D	2.80	3.00	3.20	0.110	0.118	0.126
E	4.65	4.90	5.15	0.183	0.193	0.203
E1	2.80	3.00	3.10	0.110	0.118	0.122
e		0.65			0.026	
L	0.40	0.60	0.80	0.016	0.024	0.031
L1		0.95			0.037	
L2		0.25			0.010	
k	0		8			
ccc			0.10			0.004

4 Ordering information

Table 8. Order codes

Part number	Temperature range	Package	Packing	Marking
TS3022ID	-40° C, +125° C	SO-8	Tube	3022I
TS3022IDT		SO-8	Tape & reel	3022I
TS3022IST		MiniSO-8	Tape & reel	K521

5 Revision history

Table 9. Document revision history

Date	Revision	Changes
29-Jan-2009	1	Initial release. The information contained in this datasheet was previously included in the TS3021-TS3022 datasheet (revision 4 dated October 2007). The single version (TS3021) and dual version (TS3022) have now been split into two separate datasheets. Refer to the TS3021 revision 5 for a complete history of changes.
25-Jun-2009	2	Modified ESD tolerances in Table 1: Absolute maximum ratings . In Table 3 , Table 4 and Table 5 : <ul style="list-style-type: none"> – modified V_{IO} typical value and maximum limits. – modified I_{IB} typical value. – modified I_{CC} typical values and corrected maximum limits. – modified I_{SC} typical values. – modified V_{OH} and V_{OL} typical values. – modified CMRR and SVR typical values. – modified TP_{HL} and TP_{LH} typical values. – modified note 3. – added note 4. Modified all curves.

Please Read Carefully:

Information in this document is provided solely in connection with ST products. STMicroelectronics NV and its subsidiaries ("ST") reserve the right to make changes, corrections, modifications or improvements, to this document, and the products and services described herein at any time, without notice.

All ST products are sold pursuant to ST's terms and conditions of sale.

Purchasers are solely responsible for the choice, selection and use of the ST products and services described herein, and ST assumes no liability whatsoever relating to the choice, selection or use of the ST products and services described herein.

No license, express or implied, by estoppel or otherwise, to any intellectual property rights is granted under this document. If any part of this document refers to any third party products or services it shall not be deemed a license grant by ST for the use of such third party products or services, or any intellectual property contained therein or considered as a warranty covering the use in any manner whatsoever of such third party products or services or any intellectual property contained therein.

UNLESS OTHERWISE SET FORTH IN ST'S TERMS AND CONDITIONS OF SALE ST DISCLAIMS ANY EXPRESS OR IMPLIED WARRANTY WITH RESPECT TO THE USE AND/OR SALE OF ST PRODUCTS INCLUDING WITHOUT LIMITATION IMPLIED WARRANTIES OF MERCHANTABILITY, FITNESS FOR A PARTICULAR PURPOSE (AND THEIR EQUIVALENTS UNDER THE LAWS OF ANY JURISDICTION), OR INFRINGEMENT OF ANY PATENT, COPYRIGHT OR OTHER INTELLECTUAL PROPERTY RIGHT.

UNLESS EXPRESSLY APPROVED IN WRITING BY AN AUTHORIZED ST REPRESENTATIVE, ST PRODUCTS ARE NOT RECOMMENDED, AUTHORIZED OR WARRANTED FOR USE IN MILITARY, AIR CRAFT, SPACE, LIFE SAVING, OR LIFE SUSTAINING APPLICATIONS, NOR IN PRODUCTS OR SYSTEMS WHERE FAILURE OR MALFUNCTION MAY RESULT IN PERSONAL INJURY, DEATH, OR SEVERE PROPERTY OR ENVIRONMENTAL DAMAGE. ST PRODUCTS WHICH ARE NOT SPECIFIED AS "AUTOMOTIVE GRADE" MAY ONLY BE USED IN AUTOMOTIVE APPLICATIONS AT USER'S OWN RISK.

Resale of ST products with provisions different from the statements and/or technical features set forth in this document shall immediately void any warranty granted by ST for the ST product or service described herein and shall not create or extend in any manner whatsoever, any liability of ST.

ST and the ST logo are trademarks or registered trademarks of ST in various countries.

Information in this document supersedes and replaces all information previously supplied.

The ST logo is a registered trademark of STMicroelectronics. All other names are the property of their respective owners.

© 2009 STMicroelectronics - All rights reserved

STMicroelectronics group of companies

Australia - Belgium - Brazil - Canada - China - Czech Republic - Finland - France - Germany - Hong Kong - India - Israel - Italy - Japan - Malaysia - Malta - Morocco - Philippines - Singapore - Spain - Sweden - Switzerland - United Kingdom - United States of America

www.st.com

Mouser Electronics

Authorized Distributor

Click to View Pricing, Inventory, Delivery & Lifecycle Information:

[STMicroelectronics:](#)

[TS3022IDT](#) [TS3022ID](#) [TS3022IST](#)