

## Single channel high side driver for automotive applications

### Features

Max transient supply voltage	$V_{CC}$	41V
Operating voltage range	$V_{CC}$	4.5 to 28V
Max On-state resistance (per ch.)	$R_{ON}$	160 m $\Omega$
Current limitation (typ)	$I_{LIMH}$	10A
Off state supply current	$I_S$	2 $\mu$ A <sup>(1)</sup>

1. Typical value with all loads connected.

- General
  - Inrush current active management by power limitation
  - Very low stand-by current
  - 3.0V CMOS compatible inputs
  - Optimized electromagnetic emissions
  - Very low electromagnetic susceptibility
  - In compliance with the 2002/95/EC european directive
- Diagnostic functions
  - Open Drain status output
  - On-state open load detection
  - Off-state open load detection
  - Output short to  $V_{CC}$  detection
  - Overload and short to ground (power limitation) indication
  - Thermal shut-down indication
- Protections
  - Undervoltage shut-down
  - Overvoltage clamp
  - Load current limitation
  - Self limiting of fast thermal transients
  - Protection against loss of ground and loss of  $V_{CC}$
  - Over-temperature shut-down with autorestart (thermal shut-down)
  - Reverse battery protected <sup>(a)</sup>
  - Electrostatic discharge protection

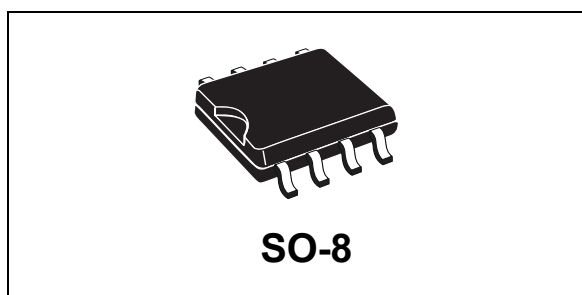

### Application

- All types of resistive, inductive and capacitive loads

### Description

The VN5E160S-E is a single channel high-side driver manufactured in the ST proprietary VIPower M0-5 technology and housed in the tiny SO-8 package.

The VN5E160S-E is designed to drive automotive grounded loads delivering protection, diagnostics and easy 3V and 5V CMOS-compatible interface with any microcontroller.

The device integrates advanced protective functions such as load current limitation, inrush and overload active management by power limitation, over-temperature shut-off with auto-restart and over-voltage active clamp.

A dedicated active low digital status pin is associated with every output channel in order to provide *Enhanced* diagnostic functions including fast detection of overload and short-circuit to ground, over-temperature indication, short-circuit to  $V_{CC}$  diagnosis and ON & OFF state open-load detection.

The diagnostic feedback of the whole device can be disabled by pulling the STAT\_DIS pin up, thus allowing wired-ORing with other similar devices.

a. See [Figure 32: Application schematic](#).

# Contents

<b>1</b>	<b>Block diagram and pin configuration</b>	<b>5</b>
<b>2</b>	<b>Electrical specifications</b>	<b>7</b>
2.1	Absolute maximum ratings	7
2.2	Electrical characteristics	9
2.3	Waveforms	15
2.4	Electrical characteristics curves	19
<b>3</b>	<b>Application information</b>	<b>22</b>
3.1	GND protection network against reverse battery	22
3.1.1	Solution 1: resistor in the ground line (RGND only)	22
3.1.2	Solution 2: diode (DGND) in the ground line	23
3.2	Load dump protection	23
3.3	MCU I/Os protection	23
3.4	Open load detection in Off state	24
3.5	Maximum demagnetization energy (VCC = 13.5V)	25
<b>4</b>	<b>Package and PCB thermal data</b>	<b>26</b>
4.1	SO-8 thermal data	26
<b>5</b>	<b>Package and packing information</b>	<b>29</b>
5.1	ECOPACK <sup>®</sup> packages	29
5.2	Package mechanical data	29
5.3	Packing information	31
<b>6</b>	<b>Order codes</b>	<b>32</b>
<b>7</b>	<b>Revision history</b>	<b>33</b>

## List of tables

Table 1.	Pin function . . . . .	5
Table 2.	Suggested connections for unused and not connected pins . . . . .	6
Table 3.	Absolute maximum ratings . . . . .	7
Table 4.	Thermal data . . . . .	8
Table 5.	Power section . . . . .	9
Table 6.	Switching ( $V_{CC} = 13V$ ; $T_j = 25^{\circ}C$ ) . . . . .	9
Table 7.	Status pin ( $V_{SD}=0$ ) . . . . .	10
Table 8.	Protection . . . . .	10
Table 9.	Open load detection ( $8V < V_{CC} < 18V$ ) . . . . .	11
Table 10.	Logic input . . . . .	11
Table 11.	Truth table. . . . .	13
Table 12.	Electrical transient requirements . . . . .	14
Table 13.	Thermal parameter . . . . .	28
Table 14.	SO-8 mechanical data . . . . .	30
Table 15.	Device summary . . . . .	32
Table 16.	Document revision history . . . . .	33

## List of figures

Figure 1.	Block diagram . . . . .	5
Figure 2.	Configuration diagram (top view) . . . . .	6
Figure 3.	Current and voltage conventions . . . . .	7
Figure 4.	Status timings . . . . .	12
Figure 5.	Output voltage drop limitation . . . . .	12
Figure 6.	Switching characteristics . . . . .	13
Figure 7.	Normal operation . . . . .	15
Figure 8.	Undervoltage shut-down . . . . .	15
Figure 9.	Overload or Short to GND . . . . .	16
Figure 10.	Intermittent Overload . . . . .	16
Figure 11.	Open Load with external pull-up . . . . .	17
Figure 12.	Open Load without external pull-up . . . . .	17
Figure 13.	Short to $V_{CC}$ . . . . .	18
Figure 14.	$T_J$ evolution in Overload or Short to GND . . . . .	18
Figure 15.	Off state output current . . . . .	19
Figure 16.	High level input current . . . . .	19
Figure 17.	Input clamp voltage . . . . .	19
Figure 18.	Input high level . . . . .	19
Figure 19.	Input low level . . . . .	19
Figure 20.	Low level STAT_DIS current . . . . .	19
Figure 21.	On state resistance vs $T_{case}$ . . . . .	20
Figure 22.	High level STAT_DIS current . . . . .	20
Figure 23.	On state resistance vs $V_{CC}$ . . . . .	20
Figure 24.	Low level input current . . . . .	20
Figure 25.	$I_{LIM}$ vs $T_{case}$ . . . . .	20
Figure 26.	Turn-On voltage slope . . . . .	20
Figure 27.	Undervoltage shutdown . . . . .	21
Figure 28.	Turn-Off voltage slope . . . . .	21
Figure 29.	STAT_DIS clamp voltage . . . . .	21
Figure 30.	High level STAT_DIS voltage . . . . .	21
Figure 31.	Low level STAT_DIS voltage . . . . .	21
Figure 32.	Application schematic . . . . .	22
Figure 33.	Open load detection in Off state . . . . .	24
Figure 34.	Maximum turn-off current versus inductance (for each channel) . . . . .	25
Figure 35.	SO-8 PC board . . . . .	26
Figure 36.	$R_{thj-amb}$ Vs. PCB copper area in open box free air condition . . . . .	26
Figure 37.	SO-8 thermal impedance junction ambient single pulse . . . . .	27
Figure 38.	Thermal fitting model of a single channel HSD in SO-8 . . . . .	27
Figure 39.	SO-8 package dimensions . . . . .	29
Figure 40.	SO-8 tube shipment (no suffix) . . . . .	31
Figure 41.	SO-8 tape and reel shipment (suffix "TR") . . . . .	31

# 1 Block diagram and pin configuration

Figure 1. Block diagram

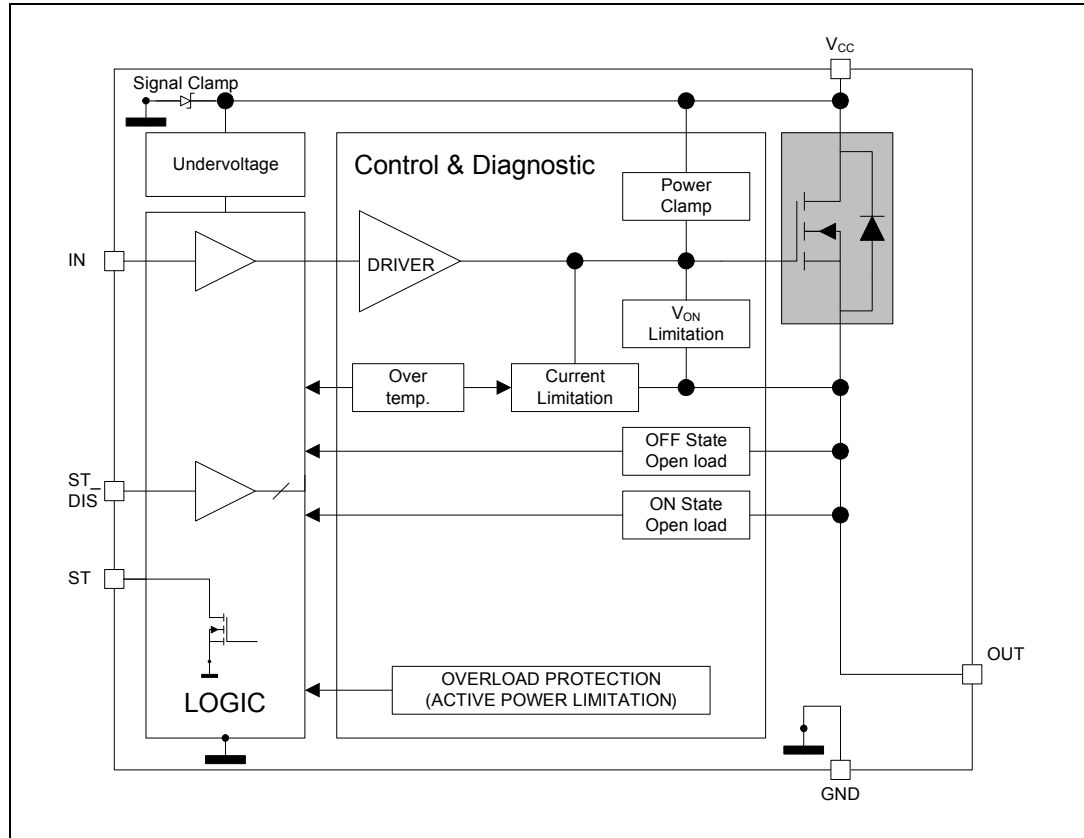

Table 1. Pin function

Name	Function
V <sub>CC</sub>	Battery connection.
OUTPUT	Power output.
GND	Ground connection. Must be reverse battery protected by an external diode/ resistor network.
INPUT	Voltage controlled input pin with hysteresis, CMOS compatible. Controls output switch state.
STATUS	Open Drain digital diagnostic pin.
STAT_DIS	Active high CMOS compatible pin, to disable the STATUS pin.

Figure 2. Configuration diagram (top view)

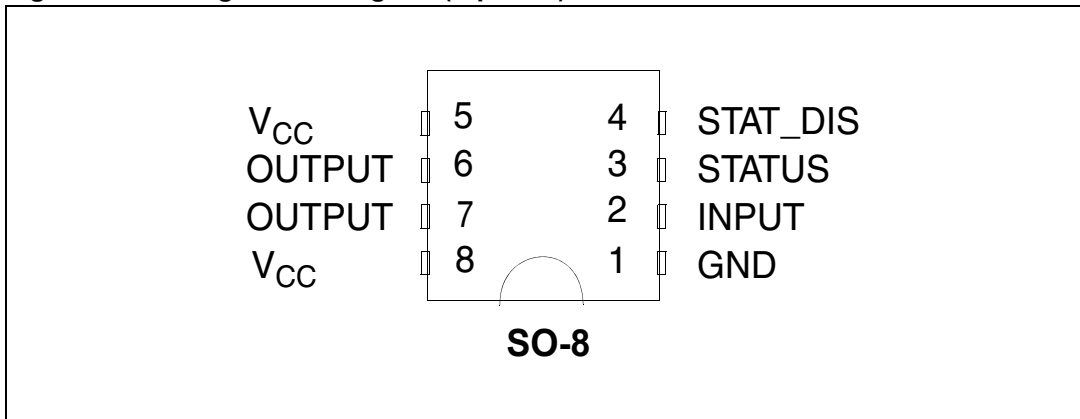
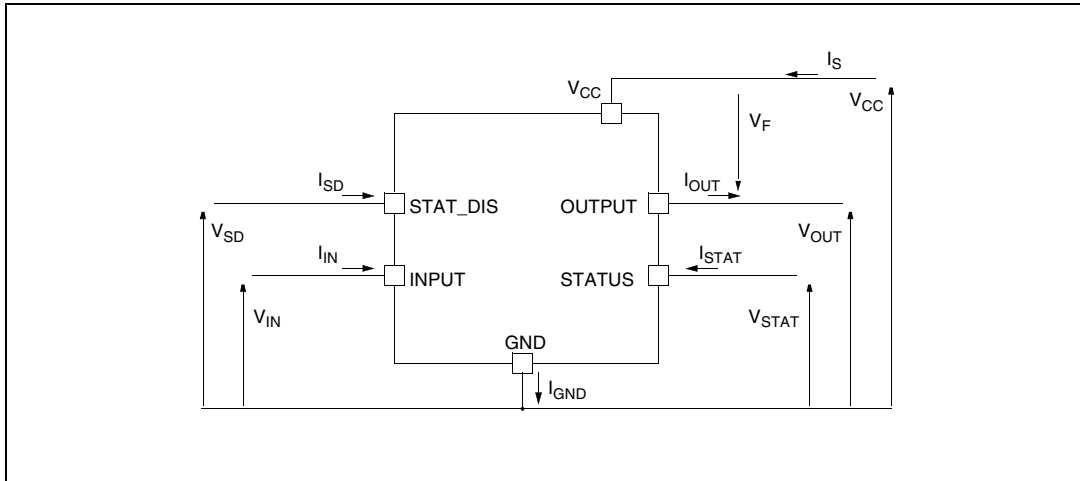

Table 2. Suggested connections for unused and not connected pins

Connection / pin	Status	N.C.	Output	Input	STAT_DIS
Floating	X	X	X	X	X
To ground	Not allowed	X	Not allowed	Through 10KΩ resistor	Through 10KΩ resistor

## 2 Electrical specifications

Figure 3. Current and voltage conventions



Note:  $V_F = V_{OUT} - V_{CC}$  during reverse battery condition.

### 2.1 Absolute maximum ratings

Stressing the device above the ratings listed in the “Absolute maximum ratings” tables may cause permanent damage to the device. These are stress ratings only and operation of the device at these or any other conditions above those indicated in the Operating sections of this specification is not implied. Exposure to the conditions in the “Absolute maximum ratings” tables for extended periods may affect device reliability. Refer also to the STMicroelectronics SURE Program and others relevant quality documents.

Table 3. Absolute maximum ratings

Symbol	Parameter	Value	Unit
V <sub>CC</sub>	DC supply voltage	41	V
- V <sub>CC</sub>	Reverse DC supply voltage	0.3	V
- I <sub>GND</sub>	DC reverse ground pin current	200	mA
I <sub>OUT</sub>	DC output current	Internally limited	A
- I <sub>OUT</sub>	Reverse DC output current	6	A
I <sub>IN</sub>	DC input current	+10 / -1	mA
I <sub>STAT</sub>	DC status current	+10 / -1	mA
I <sub>STAT_DIS</sub>	DC status disable current	+10 / -1	mA
E <sub>MAX</sub>	Maximum switching energy (single pulse) (L=8 mH; R <sub>L</sub> =0Ω; V <sub>bat</sub> =13.5V; T <sub>Jstart</sub> =150°C; I <sub>OUT</sub> = I <sub>limL</sub> (Typ.))	36	mJ

**Table 3. Absolute maximum ratings (continued)**

Symbol	Parameter	Value	Unit
V <sub>ESD</sub>	Electrostatic discharge (Human body model: R=1.5KΩ; C=100pF)		
	– INPUT	4000	V
	– STATUS	4000	V
	– STAT_DIS	4000	V
	– OUTPUT	5000	V
	– V <sub>CC</sub>	5000	V
V <sub>ESD</sub>	Charge device model (CDM-AEC-Q100-011)	750	V
T <sub>j</sub>	Junction operating temperature	-40 to 150	°C
T <sub>stg</sub>	Storage temperature	- 55 to 150	°C

**Table 4. Thermal data**

Symbol	Parameter	Max. value	Unit
R <sub>thj-pins</sub>	Thermal resistance junction-pins	30	°C/W
R <sub>thj-amb</sub>	Thermal resistance junction-ambient	See <a href="#">Figure 36</a> .	°C/W



## 2.2 Electrical characteristics

Values specified in this section are for  $8V < V_{CC} < 28V$ ;  $-40^{\circ}C < T_j < 150^{\circ}C$ , unless otherwise stated.

**Table 5. Power section**

Symbol	Parameter	Test conditions	Min.	Typ.	Max.	Unit
$V_{CC}$	Operating supply voltage		4.5	13	28	V
$V_{USD}$	Undervoltage shut-down			3.5	4.5	V
$V_{USDhyst}$	Undervoltage shut-down hysteresis			0.5		V
$R_{ON}$	On state resistance	$I_{OUT}=1A$ ; $T_j=25^{\circ}C$			160	m $\Omega$
		$I_{OUT}=1A$ ; $T_j=150^{\circ}C$			320	m $\Omega$
		$I_{OUT}=1A$ ; $V_{CC}=5V$ ; $T_j=25^{\circ}C$			210	m $\Omega$
$V_{clamp}$	Clamp voltage	$I_S=20$ mA	41	46	52	V
$I_S$	Supply current	Off State; $V_{CC}=13V$ ; $V_{IN}=V_{OUT}=0V$ ; $T_j=25^{\circ}C$		2 <sup>(1)</sup>	5 <sup>(1)</sup>	$\mu A$
		On State; $V_{IN}=5V$ ; $V_{CC}=13V$ ; $I_{OUT}=0A$		1.9	3.5	mA
$I_{L(off1)}$	Off state output current	$V_{IN}=V_{OUT}=0V$ ; $V_{CC}=13V$ ; $T_j=25^{\circ}C$	0	0.01	3	$\mu A$
		$V_{IN}=V_{OUT}=0V$ ; $V_{CC}=13V$ ; $T_j=125^{\circ}C$	0		5	$\mu A$
$V_F$	Output - $V_{CC}$ diode voltage	$-I_{OUT}=0.6A$ ; $T_j=150^{\circ}C$			0.7	V

1. PowerMOS leakage included.

**Table 6. Switching ( $V_{CC} = 13V$ ;  $T_j = 25^{\circ}C$ )**

Symbol	Parameter	Test conditions	Min.	Typ.	Max.	Unit
$t_{d(on)}$	Turn-On delay time	$R_L=13\Omega$ (see <a href="#">Figure 6.</a> )		10		$\mu s$
$t_{d(off)}$	Turn-Off delay time	$R_L=13\Omega$ (see <a href="#">Figure 6.</a> )		15		$\mu s$
$dV_{OUT}/dt_{(on)}$	Turn-On voltage slope	$R_L=13\Omega$		See <a href="#">Figure 26.</a>		V/ $\mu s$
$dV_{OUT}/dt_{(off)}$	Turn-Off voltage slope	$R_L=13\Omega$		See <a href="#">Figure 28.</a>		V/ $\mu s$
$W_{ON}$	Switching energy losses during $t_{won}$	$R_L=13\Omega$ (see <a href="#">Figure 6.</a> )		70		$\mu J$
$W_{OFF}$	Switching energy losses during $t_{woff}$	$R_L=13\Omega$ (see <a href="#">Figure 6.</a> )		40		$\mu J$

**Table 7. Status pin ( $V_{SD}=0$ )**

Symbol	Parameter	Test conditions	Min.	Typ.	Max.	Unit
$V_{STAT}$	Status low output voltage	$I_{STAT}= 1.6 \text{ mA}$ , $V_{SD}=0V$			0.5	V
$I_{LSTAT}$	Status leakage current	Normal operation or $V_{SD}=5V$ , $V_{STAT}= 5V$			10	$\mu A$
$C_{STAT}$	Status pin input capacitance	Normal operation or $V_{SD}=5V$ , $V_{STAT}= 5V$			100	pF
$V_{SCL}$	Status clamp voltage	$I_{STAT}= 1mA$ $I_{STAT}= - 1mA$	5.5	-0.7	7	V V

**Table 8. Protection (1)**

Symbol	Parameter	Test conditions	Min.	Typ.	Max.	Unit
$I_{limH}$	DC short circuit current	$V_{CC}=13V$ ; $5V < V_{CC} < 28V$	7	10	14 14	A A
$I_{limL}$	Short circuit current during thermal cycling	$V_{CC}=13V$ ; $T_R < T_j < T_{TSD}$		2.5		A
$T_{TSD}$	Shutdown temperature		150	175	200	$^{\circ}C$
$T_R$	Reset temperature		$T_{RS} + 1$	$T_{RS} + 5$		$^{\circ}C$
$T_{RS}$	Thermal reset of STATUS		135			$^{\circ}C$
$T_{HYST}$	Thermal hysteresis ( $T_{TSD}-T_R$ )			7		$^{\circ}C$
$t_{SDL}$	Status delay in overload conditions	$T_j > T_{TSD}$ (see <a href="#">Figure 4</a> )			20	$\mu s$
$V_{DEMAG}$	Turn-off output voltage clamp	$I_{OUT}=1A$ ; $V_{IN}=0$ ; $L=20mH$	$V_{CC}-41$	$V_{CC}-46$	$V_{CC}-52$	V
$V_{ON}$	Output voltage drop limitation	$I_{OUT}=0.03A$ (see <a href="#">Figure 5.</a> ) $T_j = -40^{\circ}C \dots +150^{\circ}C$		25		mV

1. To ensure long term reliability under heavy overload or short circuit conditions, protection and related diagnostic signals must be used together with a proper software strategy. If the device is subjected to abnormal conditions, this software must limit the duration and number of activation cycles.

**Table 9. Open load detection (8V<V<sub>CC</sub><18V)**

Symbol	Parameter	Test conditions	Min.	Typ.	Max.	Unit
I <sub>OL</sub>	Open load ON state detection threshold	V <sub>IN</sub> = 5V	10		40	mA
t <sub>DOL(on)</sub>	Open load ON state detection delay	I <sub>OUT</sub> = 0A, V <sub>CC</sub> =13V (see <a href="#">Figure 4</a> )			200	μs
t <sub>POL</sub>	Delay between INPUT falling edge and STATUS rising edge in open load condition	I <sub>OUT</sub> = 0A (see <a href="#">Figure 4</a> )	200	500	1200	μs
V <sub>OL</sub>	Open load OFF state voltage detection threshold	V <sub>IN</sub> = 0V	2		4	V
t <sub>DSTKON</sub>	Output short circuit to V <sub>CC</sub> detection delay at turn-off	See <a href="#">Figure 4</a>	180		t <sub>POL</sub>	μs
I <sub>L(off2)</sub>	Off state output current	V <sub>IN</sub> = 0V; V <sub>OUT</sub> = 4V (see <a href="#">Section 3.4: Open load detection in Off state</a> )	-75		0	μA
td_vol	Delay response from output rising edge to STATUS falling edge in open load	V <sub>IN</sub> = 0V; V <sub>OUT</sub> = 4V			20	μs

**Table 10. Logic input**

Symbol	Parameter	Test conditions	Min.	Typ.	Max.	Unit
V <sub>IL</sub>	Input low level				0.9	V
I <sub>IL</sub>	Low level input current	V <sub>IN</sub> = 0.9V	1			μA
V <sub>IH</sub>	Input high level		2.1			V
I <sub>IH</sub>	High level input current	V <sub>IN</sub> = 2.1V			10	μA
V <sub>I(hyst)</sub>	Input hysteresis voltage		0.25			V
V <sub>ICL</sub>	Input clamp voltage	I <sub>IN</sub> = 1mA I <sub>IN</sub> = -1mA	5.5	-0.7	7	V V
V <sub>SDL</sub>	STAT_DIS low level voltage				0.9	V
I <sub>SDL</sub>	Low level STAT_DIS current	V <sub>SD</sub> =0.9V	1			μA
V <sub>SDH</sub>	STAT_DIS high level voltage		2.1			V
I <sub>SDH</sub>	High level STAT_DIS current	V <sub>SD</sub> =2.1V			10	μA
V <sub>SD(hyst)</sub>	STAT_DIS hysteresis voltage		0.25			V
V <sub>SDCL</sub>	STAT_DIS clamp voltage	I <sub>SD</sub> =1mA I <sub>SD</sub> =-1mA	5.5	-0.7	7	V V

Figure 4. Status timings

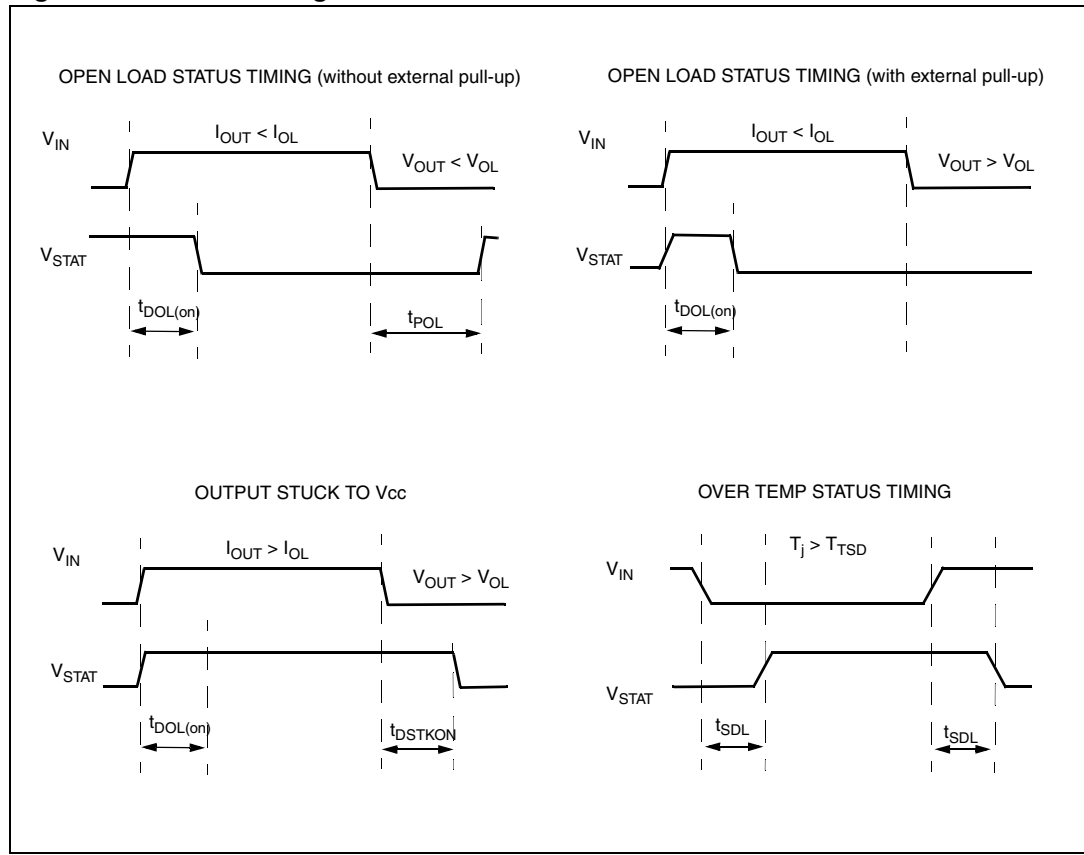

Figure 5. Output voltage drop limitation

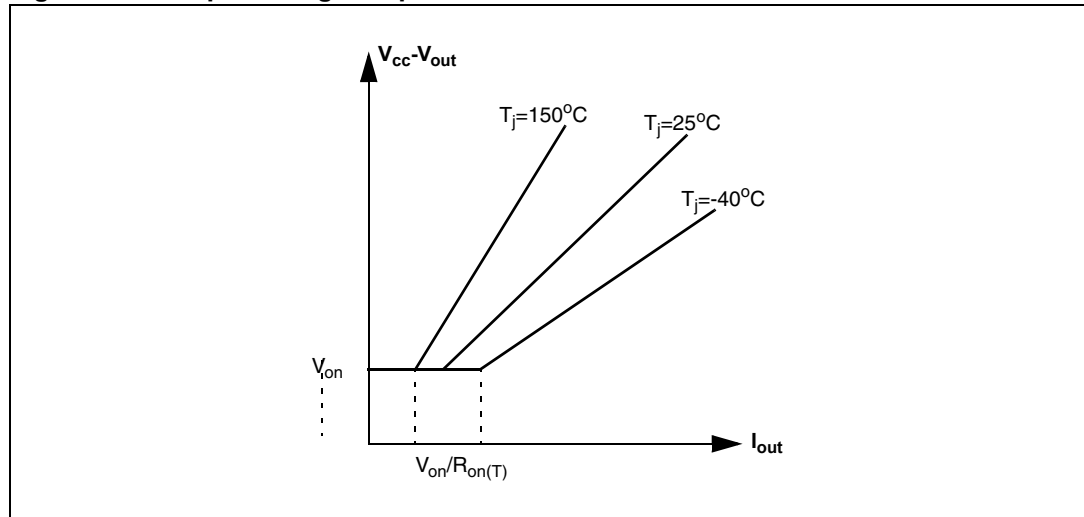

Figure 6. Switching characteristics

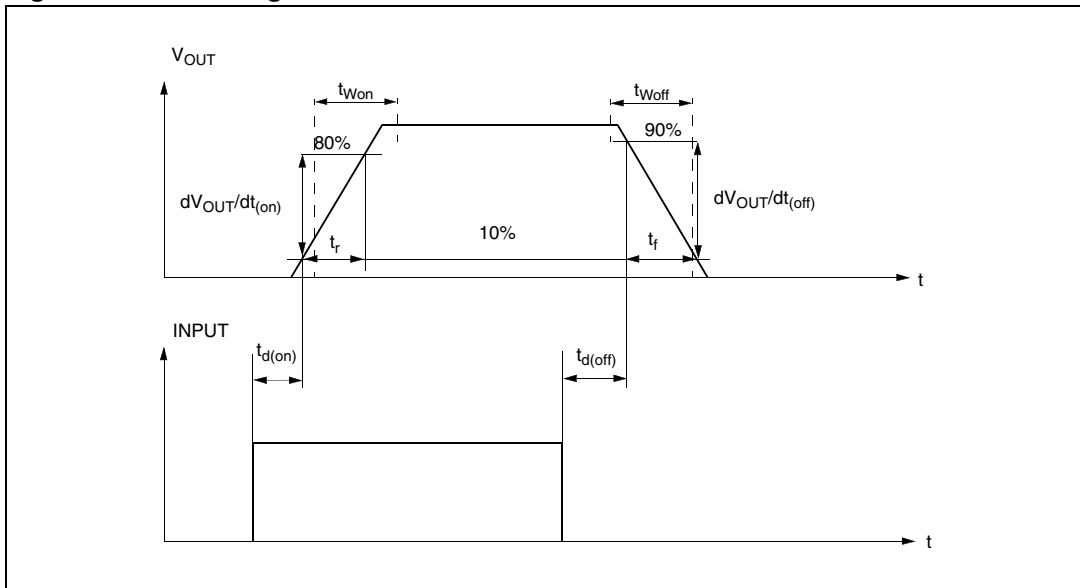

Table 11. Truth table

Conditions	INPUT	OUTPUT	STATUS ( $V_{SD}=0V$ ) <sup>(1)</sup>
Normal operation	L	L	H
	H	H	H
Overtemperature	L	L	H
	H	L	L
Undervoltage	L	L	X
	H	L	X
Overload & Short circuit to GND	H	X	H
	H	(no power limitation) Cycling (power limitation)	L
Output voltage > $V_{OL}$	L	H	L <sup>(2)</sup>
	H	H	H
Output current < $I_{OL}$	L	L	H <sup>(3)</sup>
	H	H	L

1. If the  $V_{SD}$  is high, the STATUS pin is in a high impedance.
2. The STATUS pin is low with a delay equal to  $t_{DSTKON}$  after INPUT falling edge.
3. The STATUS pin becomes high with a delay equal to  $t_{POL}$  after INPUT falling edge.

**Table 12. Electrical transient requirements**

ISO 7637-2: 2004(E) Test pulse	Test levels <sup>(1)</sup>		Number of pulses or test times	Burst cycle / pulse repetition time		Delays and impedance
	III	IV				
1	-75 V	-100 V	5000 pulses	0.5 s	5 s	2 ms, 10 Ω
2a	+37 V	+50 V	5000 pulses	0.2 s	5 s	50 μs, 2 Ω
3a	-100 V	-150 V	1h	90 ms	100 ms	0.1 μs, 50 Ω
3b	+75 V	+100 V	1h	90 ms	100 ms	0.1 μs, 50 Ω
4	-6 V	-7 V	1 pulse			100 ms, 0.01 Ω
5b <sup>(2)</sup>	+65 V	+87 V	1 pulse			400 ms, 2 Ω

ISO 7637-2: 2004(E) Test pulse	Test level results <sup>(1)</sup>	
	III	IV
1	C	C
2a	C	C
3a	C	C
3b	C	C
4	C	C
5b <sup>(2)</sup>	C	C

1. The above test levels must be considered referred to V<sub>CC</sub> = 13.5V except for pulse 5b.
2. Valid in case of external load dump clamp: 40V maximum referred to ground.

Class	Contents
C	All functions of the device are performed as designed after exposure to disturbance.
E	One or more functions of the device are not performed as designed after exposure to disturbance and cannot be returned to proper operation without replacing the device.

### 2.3 Waveforms

Figure 7. Normal operation



Figure 8. Undervoltage shut-down



Figure 9. Overload or Short to GND



Figure 10. Intermittent Overload





Figure 11. Open Load with external pull-up



Figure 12. Open Load without external pull-up



Figure 13. Short to  $V_{CC}$



Figure 14.  $T_J$  evolution in Overload or Short to GND

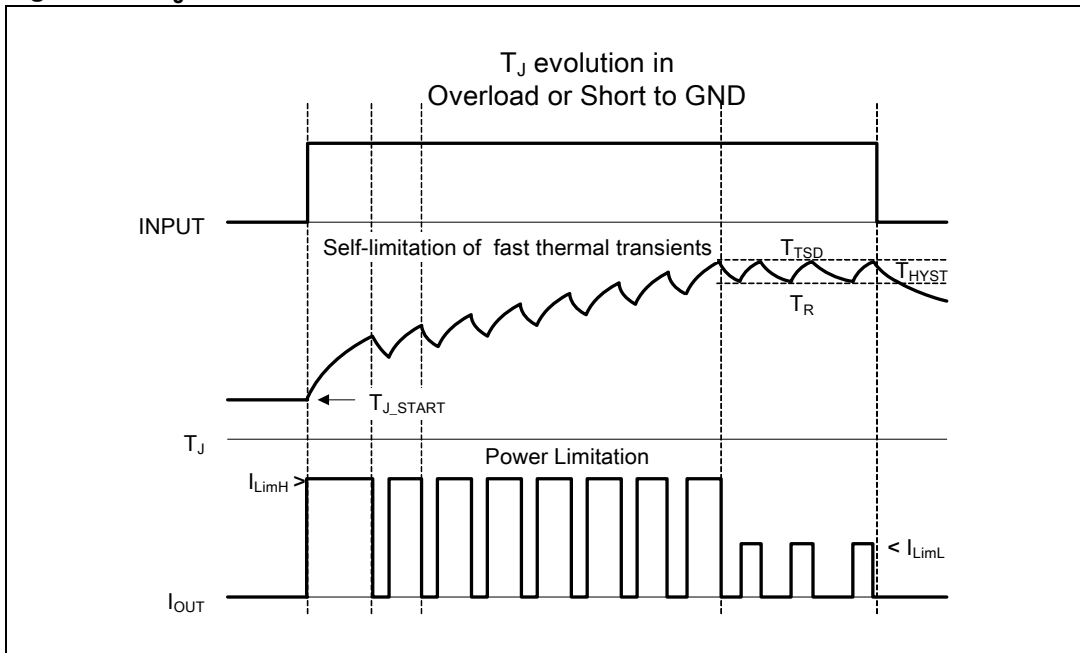

## 2.4 Electrical characteristics curves

Figure 15. Off state output current

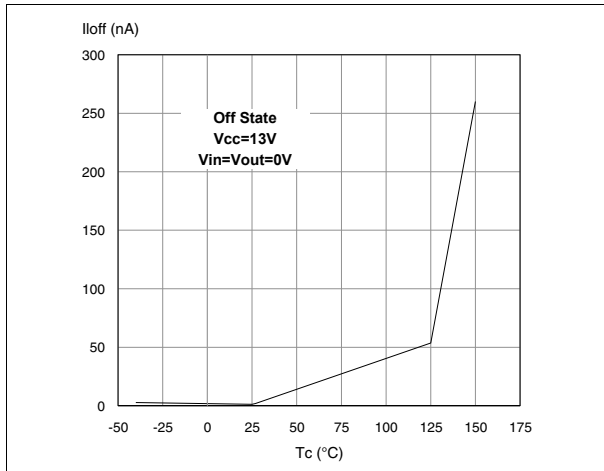

Figure 16. High level input current

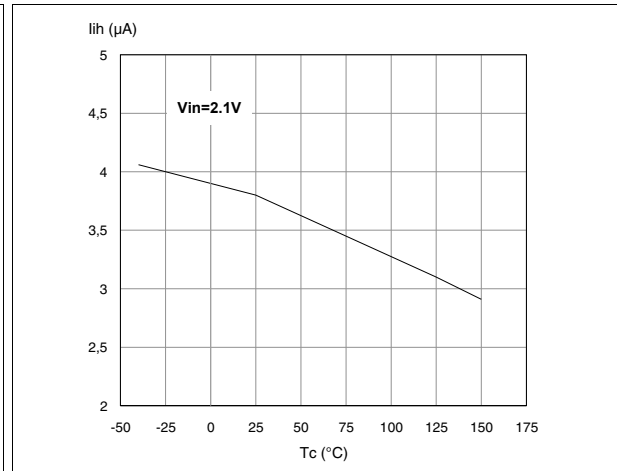

Figure 17. Input clamp voltage

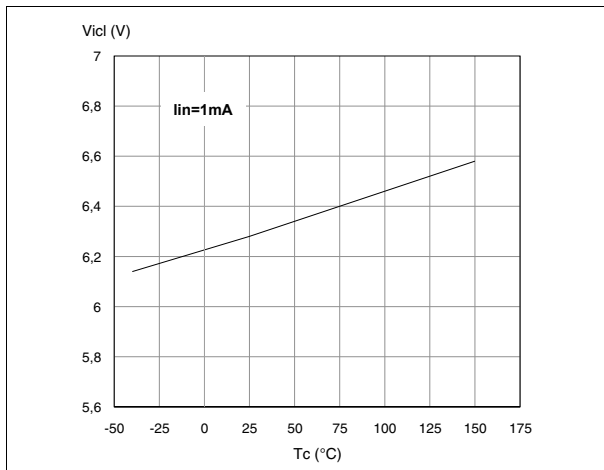

Figure 18. Input high level

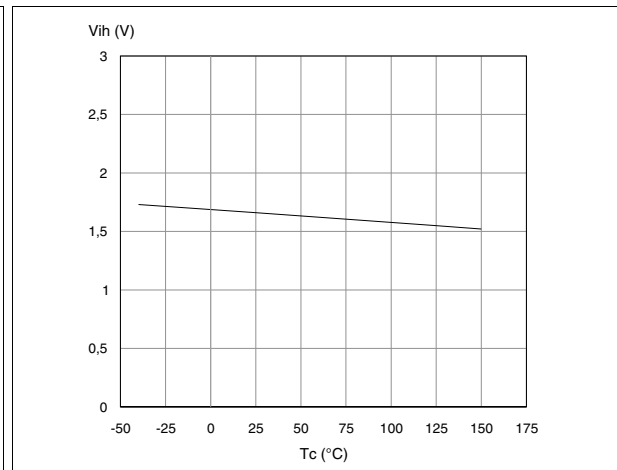

Figure 19. Input low level

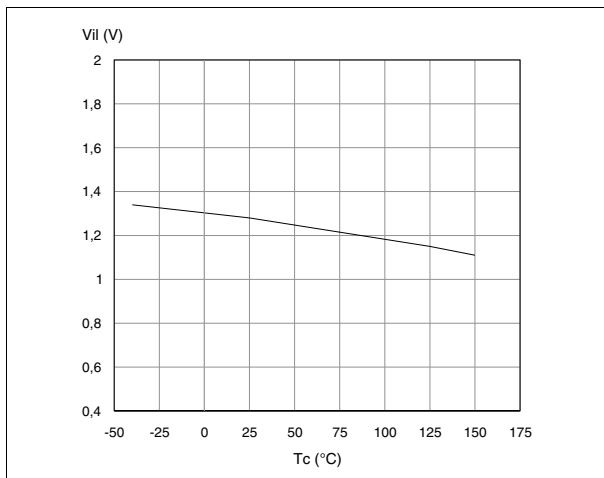

Figure 20. Low level STAT\_DIS current

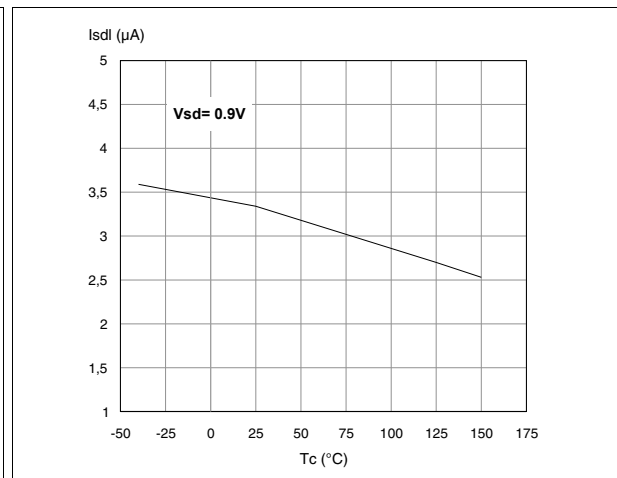

Figure 21. On state resistance vs  $T_{case}$

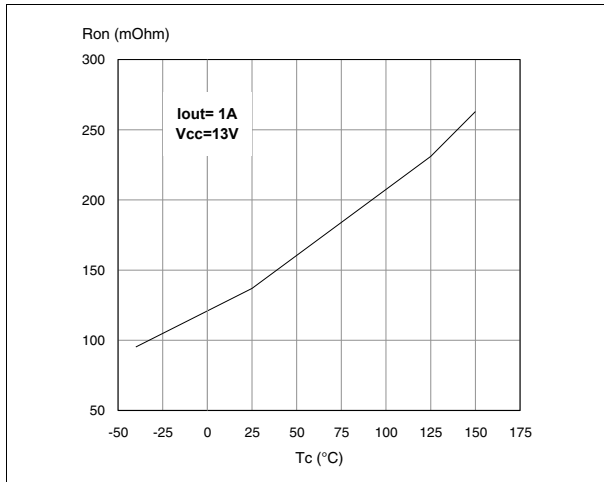

Figure 22. High level STAT\_DIS current

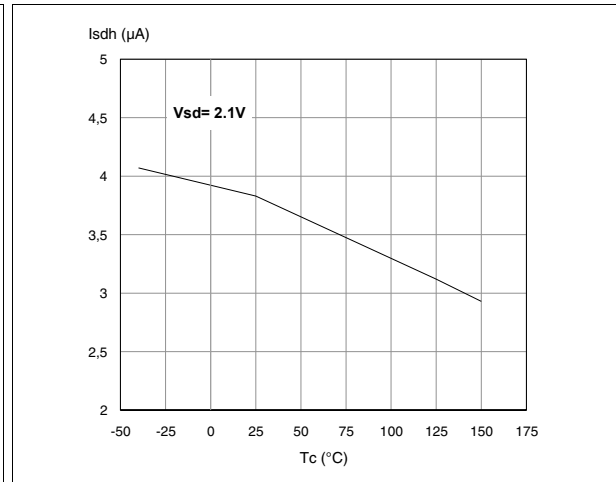

Figure 23. On state resistance vs  $V_{CC}$

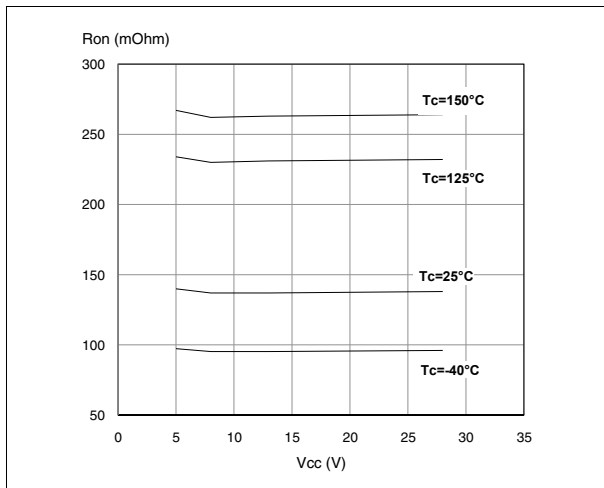

Figure 24. Low level input current

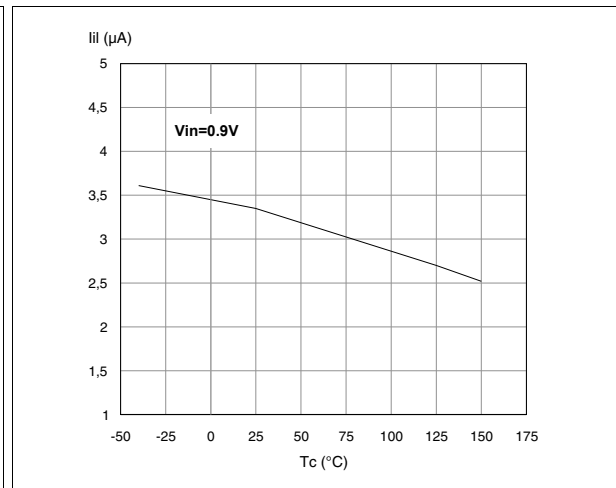

Figure 25.  $I_{LIM}$  vs  $T_{case}$

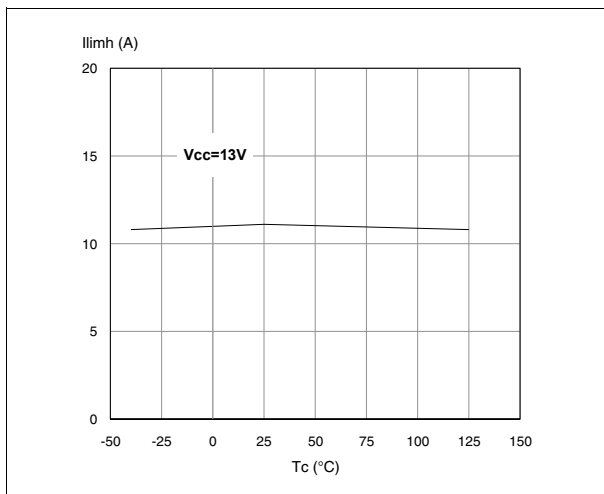

Figure 26. Turn-On voltage slope

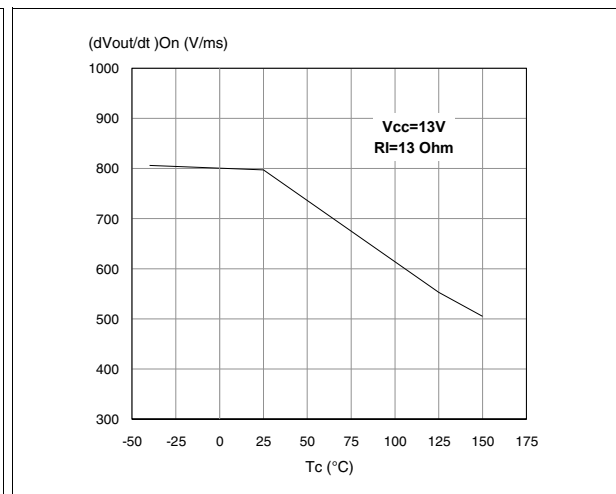

Figure 27. Undervoltage shutdown

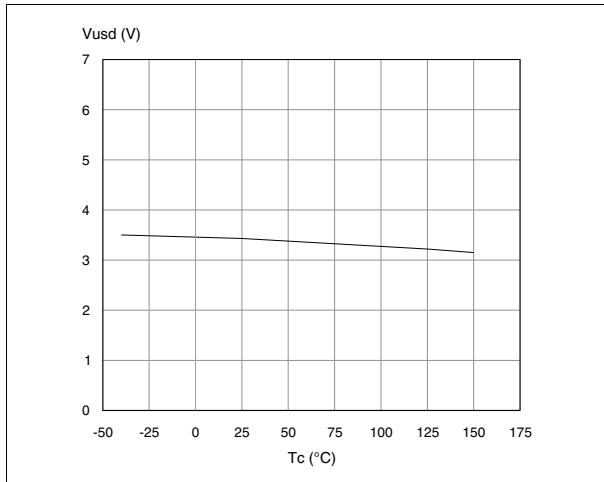

Figure 28. Turn-Off voltage slope

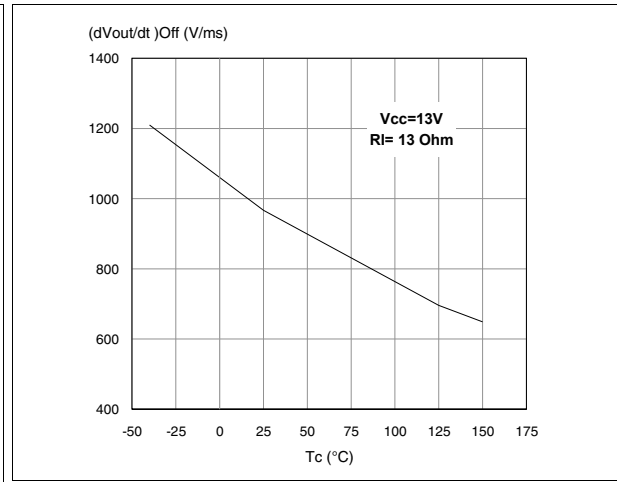

Figure 29. STAT\_DIS clamp voltage

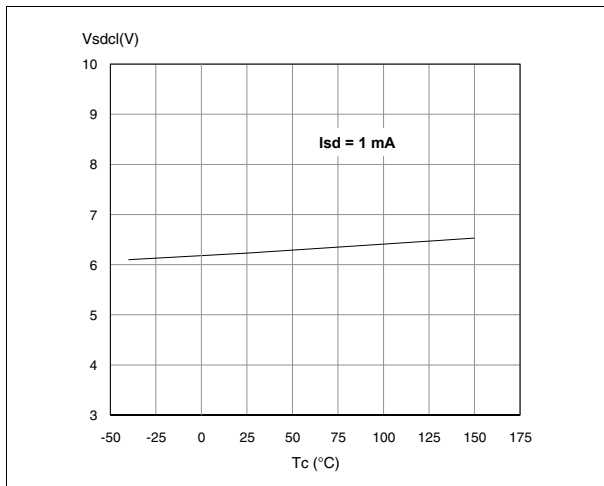

Figure 30. High level STAT\_DIS voltage

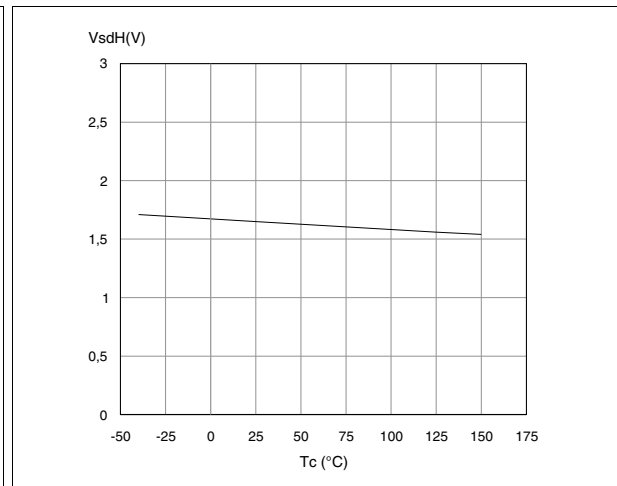
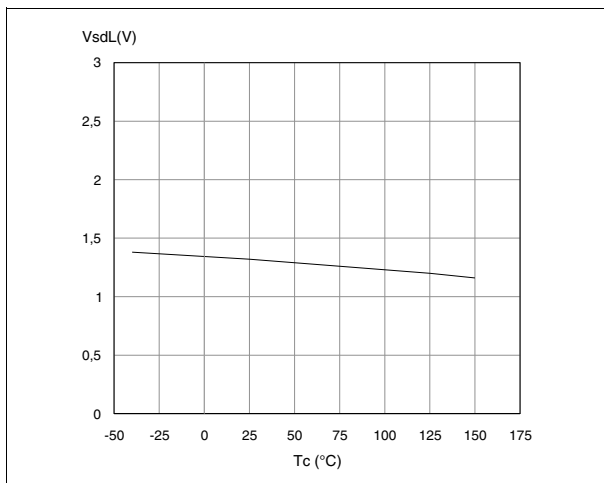
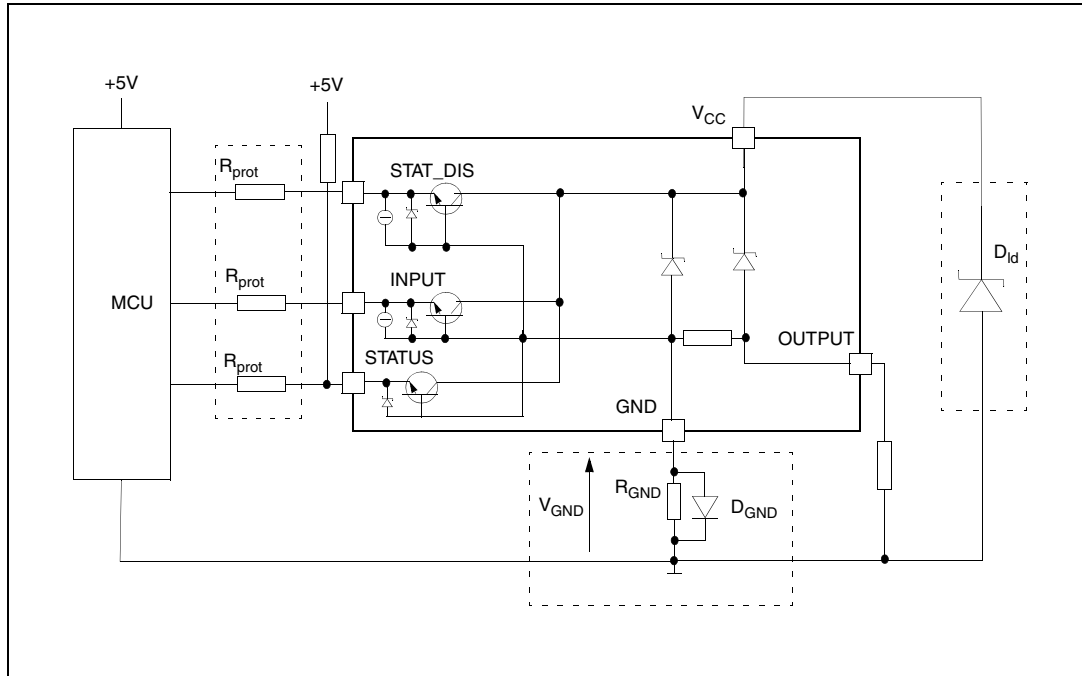

Figure 31. Low level STAT\_DIS voltage



### 3 Application information

Figure 32. Application schematic



#### 3.1 GND protection network against reverse battery

##### 3.1.1 Solution 1: resistor in the ground line (R<sub>GND</sub> only)

This solution can be used with any type of load.

The following is an indication on how to dimension the R<sub>GND</sub> resistor.

1.  $R_{GND} \leq 600\text{mV} / (I_{S(on)max})$ .
2.  $R_{GND} \geq (-V_{CC}) / (-I_{GND})$

where -I<sub>GND</sub> is the DC reverse ground pin current and can be found in the absolute maximum rating section of the device datasheet.

Power dissipation in R<sub>GND</sub> (when V<sub>CC</sub><0: during reverse battery situations) is:

$$P_D = (-V_{CC})^2 / R_{GND}$$

This resistor can be shared amongst several different HSDs. Please note that the value of this resistor should be calculated with formula (1) where I<sub>S(on)max</sub> becomes the sum of the maximum on-state currents of the different devices.

Please note that if the microprocessor ground is not shared by the device ground then the R<sub>GND</sub> will produce a shift (I<sub>S(on)max</sub> \* R<sub>GND</sub>) in the input thresholds and the status output values. This shift will vary depending on how many devices are ON in the case of several high side drivers sharing the same R<sub>GND</sub>.

If the calculated power dissipation leads to a large resistor or several devices have to share the same resistor then ST suggests Solution 2 is used (see below).

### 3.1.2 Solution 2: diode ( $D_{GND}$ ) in the ground line

A resistor ( $R_{GND}=1k\Omega$ ) should be inserted in parallel to  $D_{GND}$  if the device drives an inductive load.

This small signal diode can be safely shared amongst several different HSDs. Also in this case, the presence of the ground network will produce a shift ( $\sim 600mV$ ) in the input threshold and in the status output values, if the microprocessor ground is not common to the device ground. This shift will not vary if more than one HSD shares the same diode/resistor network.

## 3.2 Load dump protection

$D_{ld}$  is necessary (Voltage Transient Suppressor) if the load dump peak voltage exceeds to  $V_{CC}$  max DC rating. The same applies if the device is subject to transients on the  $V_{CC}$  line that are greater than the ones shown in the ISO T/R 7637/2 table.

## 3.3 MCU I/Os protection

If a ground protection network is used and negative transient are present on the  $V_{CC}$  line, the control pins will be pulled negative. ST suggests that a resistor ( $R_{prot}$ ) be inserted in line to prevent the  $\mu C$  I/Os pins to latch-up.

The value of these resistors is a compromise between the leakage current of  $\mu C$  and the current required by the HSD I/Os (Input levels compatibility) with the latch-up limit of  $\mu C$  I/Os.

$$-V_{CCpeak}/I_{latchup} \leq R_{prot} \leq (V_{OH\mu C} - V_{IH} - V_{GND}) / I_{IHmax}$$

Calculation example:

For  $V_{CCpeak} = -100V$  and  $I_{latchup} \geq 20mA$ ;  $V_{OH\mu C} \geq 4.5V$

$$5k\Omega \leq R_{prot} \leq 180k\Omega.$$

Recommended  $R_{prot}$  value is  $10k\Omega$ .

### 3.4 Open load detection in Off state

Off-state open-load detection requires an external pull-up resistor ( $R_{PU}$ ) connected between the OUTPUT pin and a positive supply voltage ( $V_{PU}$ ) like the +5V line used to supply the microprocessor.

The external resistor has to be selected according to the following requirements:

1. No false open load indication when load is connected: in this case we have to avoid  $V_{OUT}$  to be higher than  $V_{OLmin}$ ; this results in the following condition  

$$V_{OUT} = (V_{PU} / (R_L + R_{PU})) R_L < V_{OLmin}$$
2. No misdetection when load is disconnected: in this case the  $V_{OUT}$  has to be higher than  $V_{OLmax}$ ; this results in the following condition  $R_{PU} < (V_{PU} - V_{OLmax}) / I_{L(off2)}$ .

Because  $I_{s(OFF)}$  may significantly increase if  $V_{out}$  is pulled high (up to several mA), the pull-up resistor  $R_{PU}$  should be connected to a supply that is switched OFF when the module is in standby.

The values of  $V_{OLmin}$ ,  $V_{OLmax}$  and  $I_{L(off2)}$  are available in the Electrical characteristics section.

**Figure 33. Open load detection in Off state**

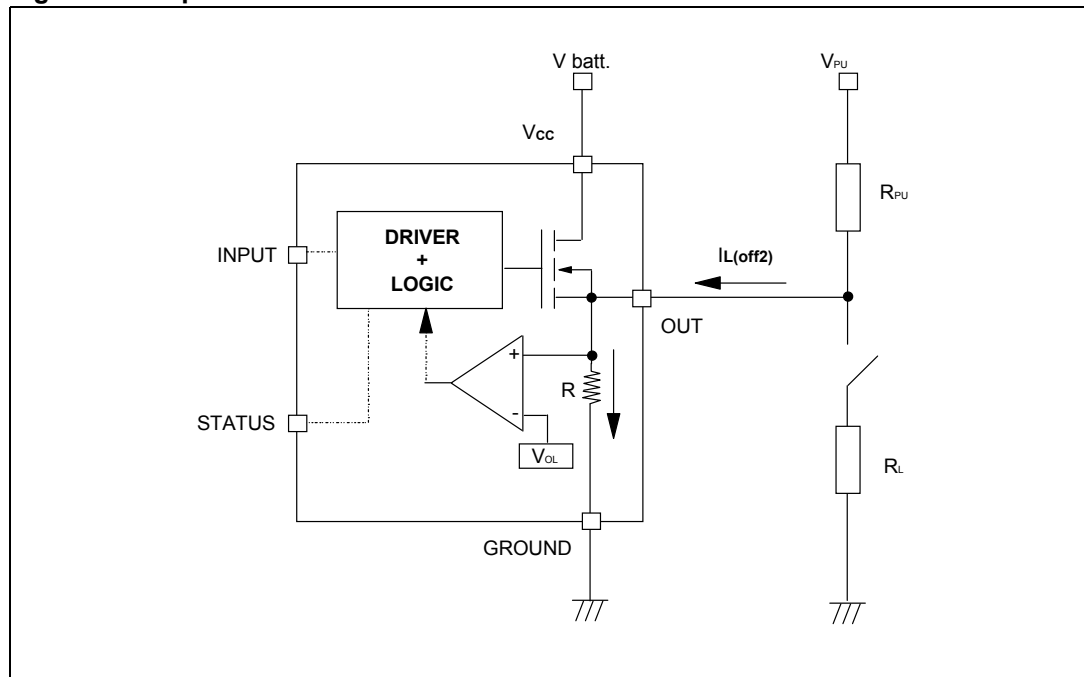



### 3.5 Maximum demagnetization energy ( $V_{CC} = 13.5V$ )

Figure 34. Maximum turn-off current versus inductance (for each channel)



Note: Values are generated with  $R_L = 0 \Omega$ .  
 In case of repetitive pulses,  $T_{jstart}$  (at beginning of each demagnetization) of every pulse must not exceed the temperature specified above for curves A and B.

## 4 Package and PCB thermal data

### 4.1 SO-8 thermal data

Figure 35. SO-8 PC board

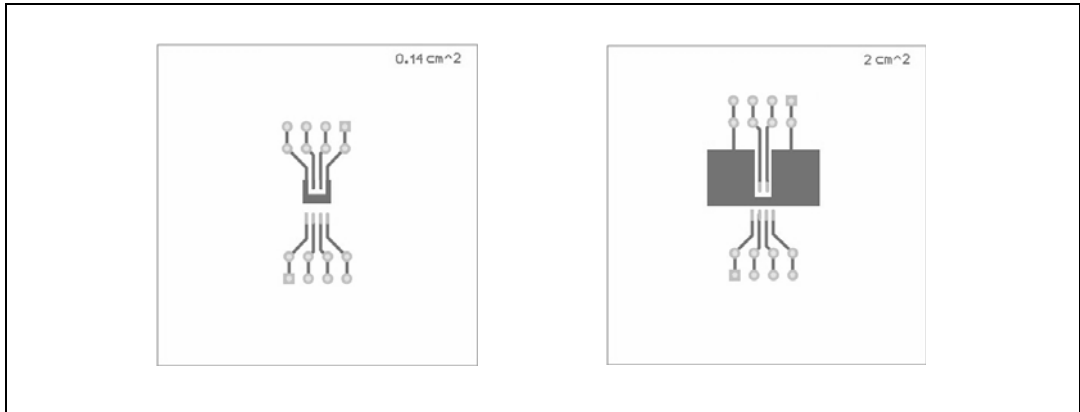

Note: Layout condition of  $R_{th}$  and  $Z_{th}$  measurements (PCB: FR4 area= 4.8mm x 4.8mm, PCB thickness=2mm, Cu thickness= 35 $\mu$ m, Copper areas: from minimum pad lay-out to 2cm<sup>2</sup>).

Figure 36.  $R_{thj-amb}$  Vs. PCB copper area in open box free air condition

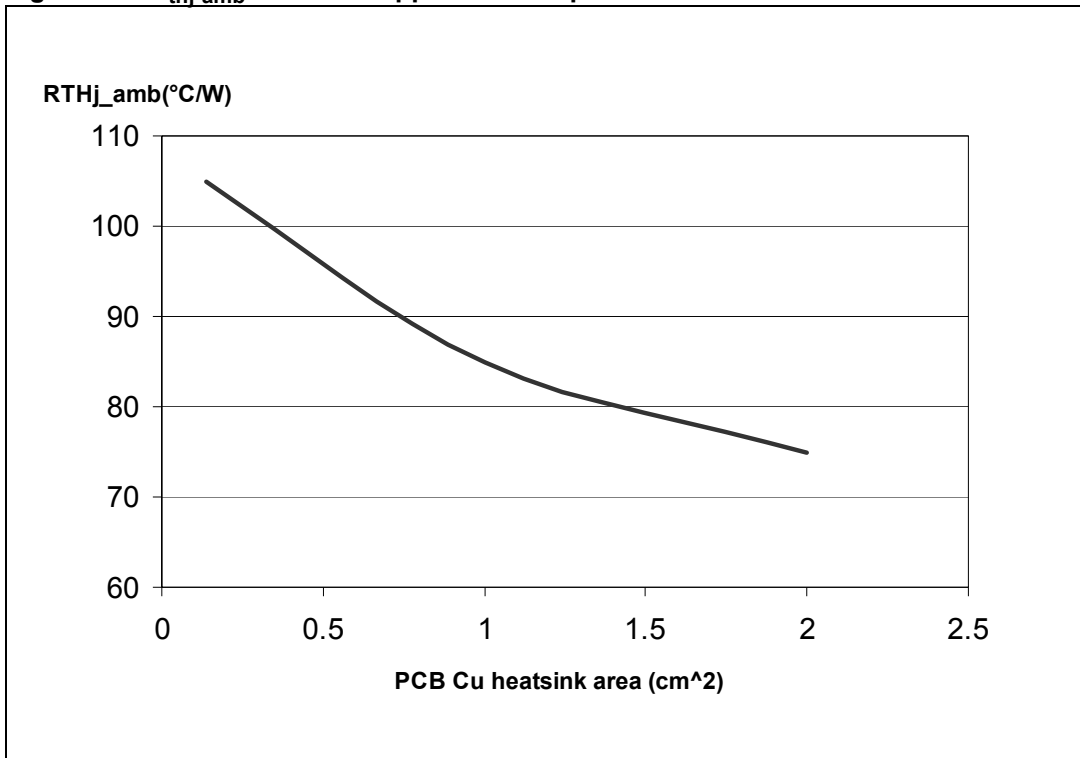
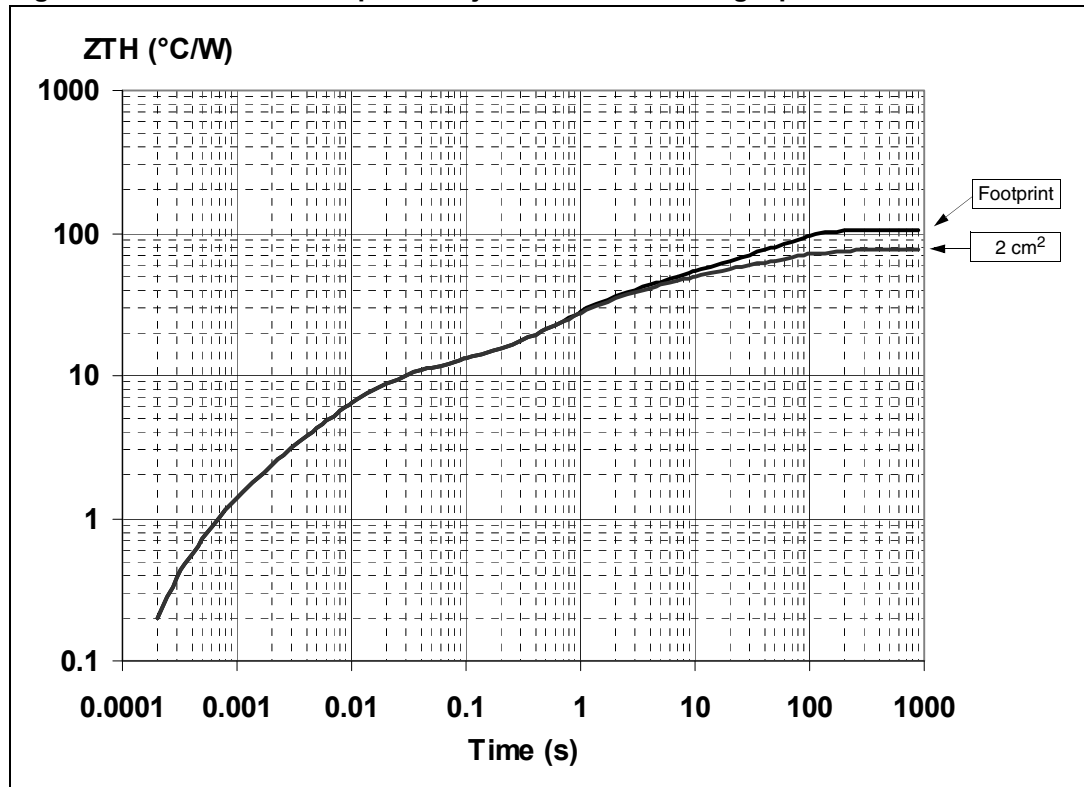

Figure 37. SO-8 thermal impedance junction ambient single pulse



Equation 1: pulse calculation formula

$$Z_{TH\delta} = R_{TH} \cdot \delta + Z_{THtp}(1 - \delta)$$

where  $\delta = t_p/T$

Figure 38. Thermal fitting model of a single channel HSD in SO-8 (b)

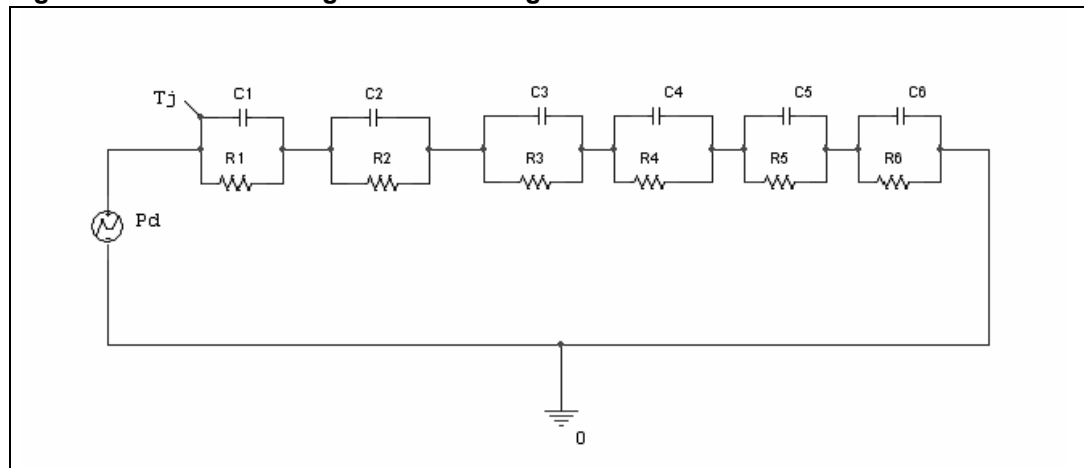

b. The fitting model is a simplified thermal tool and is valid for transient evolutions where the embedded protections (power limitation or thermal cycling during thermal shutdown) are not triggered.

Table 13. Thermal parameter

Area/island (cm <sup>2</sup> )	Footprint	2
R1 (°C/W)	1.2	
R2 (°C/W)	6	
R3 (°C/W)	3.5	
R4 (°C/W)	21	
R5 (°C/W)	16	
R6 (°C/W)	58	28
C1 (W.s/°C)	0.0008	
C2 (W.s/°C)	0.0016	
C3 (W.s/°C)	0.0075	
C4 (W.s/°C)	0.045	
C5 (W.s/°C)	0.35	
C6 (W.s/°C)	1.05	2

## 5 Package and packing information

### 5.1 ECOPACK® packages

In order to meet environmental requirements, ST offers these devices in ECOPACK® packages. These packages have a Lead-free second-level interconnect. The category of Second-Level Interconnect is marked on the package and on the inner box label, in compliance with JEDEC Standard JESD97.

The maximum ratings related to soldering conditions are also marked on the inner box label. ECOPACK is an ST trademark. ECOPACK specifications are available at: [www.st.com](http://www.st.com).

### 5.2 Package mechanical data

Figure 39. SO-8 package dimensions

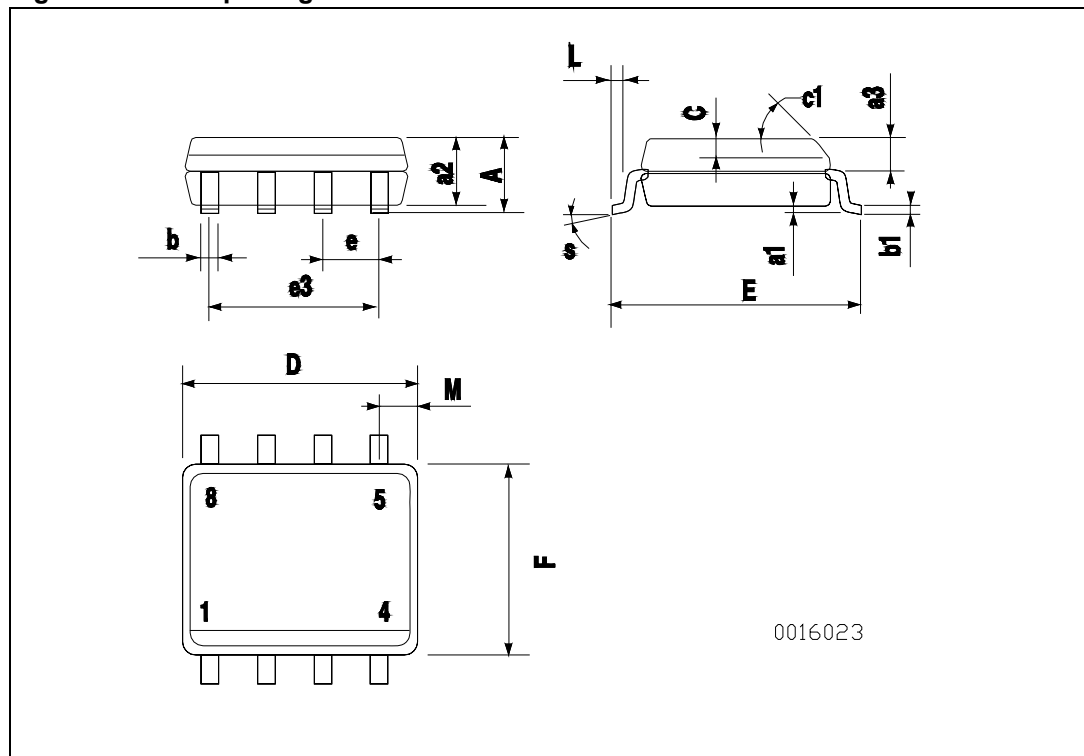

Table 14. SO-8 mechanical data

Dim.	Millimeter		
	Min.	Typ.	Max.
A			1.75
a1	0.1		0.25
a2			1.65
a3	0.65		0.85
b	0.35		0.48
b1	0.19		0.25
C	0.25		0.5
c1	45 (typ.)		
D	4.8		5
E	5.8		6.2
e		1.27	
e3		3.81	
F	3.8		4
L	0.4		1.27
M			0.6
S	8 (max.)		
L1	0.8		1.2

### 5.3 Packing information

Figure 40. SO-8 tube shipment (no suffix)

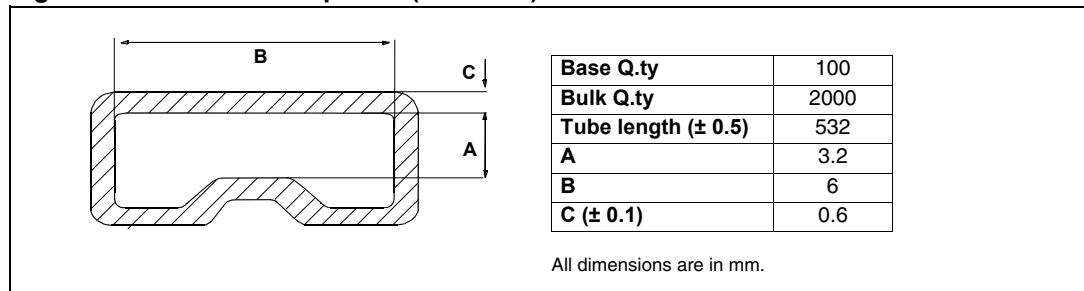
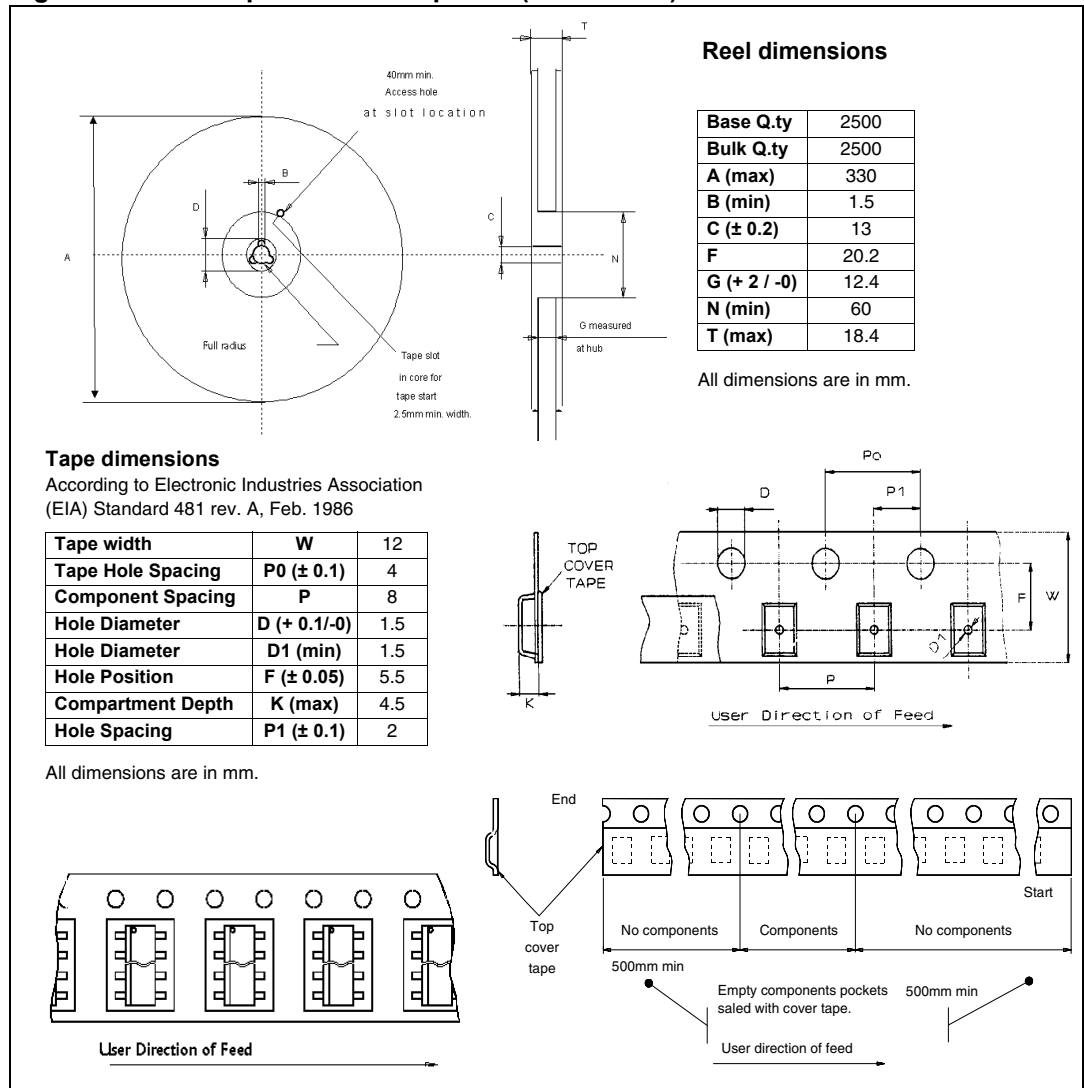

Figure 41. SO-8 tape and reel shipment (suffix "TR")



## 6 Order codes

Table 15. Device summary

Package	Order codes	
	Tube	Tape and reel
SO-8	VN5E160S-E	VN5E160STR-E



## 7 Revision history

Table 16. Document revision history

Date	Revision	Changes
4-Jun-2007	1	Initial release.
18-Feb-2008	2	Document restructured. Changed <i>Description</i> on cover page. <i>Table 9: Open load detection (8V&lt;V<sub>CC</sub>&lt;18V)</i> : added td_vol parameter. Changed <i>Section 2.3: Waveforms</i> . Added <i>Section 2.4: Electrical characteristics curves</i> . Added <i>Section 3.5: Maximum demagnetization energy (VCC = 13.5V)</i> . Added <i>Section 4.1: SO-8 thermal data</i> .
20-Sep-2013	3	Updated Disclaimer

**Please Read Carefully:**

Information in this document is provided solely in connection with ST products. STMicroelectronics NV and its subsidiaries ("ST") reserve the right to make changes, corrections, modifications or improvements, to this document, and the products and services described herein at any time, without notice.

All ST products are sold pursuant to ST's terms and conditions of sale.

Purchasers are solely responsible for the choice, selection and use of the ST products and services described herein, and ST assumes no liability whatsoever relating to the choice, selection or use of the ST products and services described herein.

No license, express or implied, by estoppel or otherwise, to any intellectual property rights is granted under this document. If any part of this document refers to any third party products or services it shall not be deemed a license grant by ST for the use of such third party products or services, or any intellectual property contained therein or considered as a warranty covering the use in any manner whatsoever of such third party products or services or any intellectual property contained therein.

**UNLESS OTHERWISE SET FORTH IN ST'S TERMS AND CONDITIONS OF SALE ST DISCLAIMS ANY EXPRESS OR IMPLIED WARRANTY WITH RESPECT TO THE USE AND/OR SALE OF ST PRODUCTS INCLUDING WITHOUT LIMITATION IMPLIED WARRANTIES OF MERCHANTABILITY, FITNESS FOR A PARTICULAR PURPOSE (AND THEIR EQUIVALENTS UNDER THE LAWS OF ANY JURISDICTION), OR INFRINGEMENT OF ANY PATENT, COPYRIGHT OR OTHER INTELLECTUAL PROPERTY RIGHT.**

**ST PRODUCTS ARE NOT DESIGNED OR AUTHORIZED FOR USE IN: (A) SAFETY CRITICAL APPLICATIONS SUCH AS LIFE SUPPORTING, ACTIVE IMPLANTED DEVICES OR SYSTEMS WITH PRODUCT FUNCTIONAL SAFETY REQUIREMENTS; (B) AERONAUTIC APPLICATIONS; (C) AUTOMOTIVE APPLICATIONS OR ENVIRONMENTS, AND/OR (D) AEROSPACE APPLICATIONS OR ENVIRONMENTS. WHERE ST PRODUCTS ARE NOT DESIGNED FOR SUCH USE, THE PURCHASER SHALL USE PRODUCTS AT PURCHASER'S SOLE RISK, EVEN IF ST HAS BEEN INFORMED IN WRITING OF SUCH USAGE, UNLESS A PRODUCT IS EXPRESSLY DESIGNATED BY ST AS BEING INTENDED FOR "AUTOMOTIVE, AUTOMOTIVE SAFETY OR MEDICAL" INDUSTRY DOMAINS ACCORDING TO ST PRODUCT DESIGN SPECIFICATIONS. PRODUCTS FORMALLY ESCC, QML OR JAN QUALIFIED ARE DEEMED SUITABLE FOR USE IN AEROSPACE BY THE CORRESPONDING GOVERNMENTAL AGENCY.**

Resale of ST products with provisions different from the statements and/or technical features set forth in this document shall immediately void any warranty granted by ST for the ST product or service described herein and shall not create or extend in any manner whatsoever, any liability of ST.

ST and the ST logo are trademarks or registered trademarks of ST in various countries.

Information in this document supersedes and replaces all information previously supplied.

The ST logo is a registered trademark of STMicroelectronics. All other names are the property of their respective owners.

© 2013 STMicroelectronics - All rights reserved

STMicroelectronics group of companies

Australia - Belgium - Brazil - Canada - China - Czech Republic - Finland - France - Germany - Hong Kong - India - Israel - Italy - Japan - Malaysia - Malta - Morocco - Philippines - Singapore - Spain - Sweden - Switzerland - United Kingdom - United States of America

[www.st.com](http://www.st.com)

# Mouser Electronics

Authorized Distributor

Click to View Pricing, Inventory, Delivery & Lifecycle Information:

[STMicroelectronics:](#)

[VN5E160S-E](#) [VN5E160STR-E](#)