

E Series Power MOSFET with Fast Body Diode

PRODUCT SUMMARY	
V_{DS} (V) at T_J max.	700
$R_{DS(on)}$ max. at 25 °C (Ω)	$V_{GS} = 10$ V 0.18
Q_g max. (nC)	106
Q_{gs} (nC)	14
Q_{gd} (nC)	33
Configuration	Single

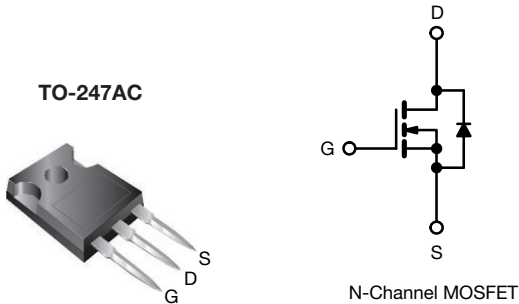

FEATURES

- Fast body diode MOSFET using E series technology
- Reduced t_{rr} , Q_{rr} , and I_{RRM}
- Low figure-of-merit (FOM) $R_{on} \times Q_g$
- Low input capacitance (C_{iss})
- Low switching losses due to reduced Q_{rr}
- Ultra low gate charge (Q_g)
- Avalanche energy rated (UIS)
- Material categorization: for definitions of compliance please see www.vishay.com/doc?99912



RoHS
COMPLIANT
HALOGEN
FREE

APPLICATIONS

- Telecommunications
 - Server and telecom power supplies
- Lighting
 - High-intensity discharge (HID)
 - Fluorescent ballast lighting
- Consumer and computing
 - ATX power supplies
- Industrial
 - Welding
 - Battery chargers
- Renewable energy
 - Solar (PV inverters)
- Switch mode power supplies (SMPS)
 - LCC
 - Phase shifted bridge (ZVS)
 - 3-level inverter
 - AC/DC bridge

ORDERING INFORMATION	
Package	TO-247AC
Lead (Pb)-free and Halogen-free	SiHG21N65EF-GE3

ABSOLUTE MAXIMUM RATINGS ($T_C = 25$ °C, unless otherwise noted)			
PARAMETER	SYMBOL	LIMIT	UNIT
Drain-Source Voltage	V_{DS}	650	V
Gate-Source Voltage	V_{GS}	± 30	
Continuous Drain Current ($T_J = 150$ °C)	V_{GS} at 10 V	$T_C = 25$ °C	A
		$T_C = 100$ °C	
Pulsed Drain Current ^a	I_{DM}	53	
Linear Derating Factor		1.7	W/°C
Single Pulse Avalanche Energy ^b	E_{AS}	367	mJ
Maximum Power Dissipation	P_D	208	W
Operating Junction and Storage Temperature Range	T_J, T_{stg}	-55 to +150	°C
Drain-Source Voltage Slope	dV/dt	$T_J = 125$ °C	V/ns
Reverse Diode dV/dt ^d			
Soldering Recommendations (Peak Temperature) ^c	for 10 s	300	°C

Notes

- Repetitive rating; pulse width limited by maximum junction temperature.
- $V_{DD} = 50$ V, starting $T_J = 25$ °C, $L = 28.2$ mH, $R_g = 25$ Ω , $I_{AS} = 5.1$ A.
- 1.6 mm from case.
- $I_{SD} \leq I_D$, $dI/dt = 100$ A/ μ s, starting $T_J = 25$ °C.

THERMAL RESISTANCE RATINGS				
PARAMETER	SYMBOL	TYP.	MAX.	UNIT
Maximum Junction-to-Ambient	R_{thJA}	-	40	°C/W
Maximum Junction-to-Case (Drain)	R_{thJC}	-	0.5	

SPECIFICATIONS ($T_J = 25\text{ }^\circ\text{C}$, unless otherwise noted)							
PARAMETER	SYMBOL	TEST CONDITIONS		MIN.	TYP.	MAX.	UNIT
Static							
Drain-Source Breakdown Voltage	V_{DS}	$V_{GS} = 0\text{ V}, I_D = 250\text{ }\mu\text{A}$		650	-	-	V
V_{DS} Temperature Coefficient	$\Delta V_{DS}/T_J$	Reference to $25\text{ }^\circ\text{C}$, $I_D = 1\text{ mA}$		-	0.67	-	V/°C
Gate-Source Threshold Voltage (N)	$V_{GS(th)}$	$V_{DS} = V_{GS}, I_D = 250\text{ }\mu\text{A}$		2	-	4	V
Gate-Source Leakage	I_{GSS}	$V_{GS} = \pm 20\text{ V}$		-	-	± 100	nA
		$V_{GS} = \pm 30\text{ V}$		-	-	± 1	μA
Zero Gate Voltage Drain Current	I_{DSS}	$V_{DS} = 520\text{ V}, V_{GS} = 0\text{ V}$		-	-	1	μA
		$V_{DS} = 520\text{ V}, V_{GS} = 0\text{ V}, T_J = 125\text{ }^\circ\text{C}$		-	-	500	
Drain-Source On-State Resistance	$R_{DS(on)}$	$V_{GS} = 10\text{ V}$	$I_D = 11\text{ A}$	-	0.15	0.18	Ω
Forward Transconductance	g_{fs}	$V_{DS} = 30\text{ V}, I_D = 11\text{ A}$		-	7.0	-	S
Dynamic							
Input Capacitance	C_{iss}	$V_{GS} = 0\text{ V},$ $V_{DS} = 100\text{ V},$ $f = 1\text{ MHz}$		-	2322	-	pF
Output Capacitance	C_{oss}			-	105	-	
Reverse Transfer Capacitance	C_{rss}			-	4	-	
Effective Output Capacitance, Energy Related ^a	$C_{o(er)}$	$V_{DS} = 0\text{ V to } 520\text{ V}, V_{GS} = 0\text{ V}$		-	84	-	pF
Effective Output Capacitance, Time Related ^b	$C_{o(tr)}$			-	293	-	
Total Gate Charge	Q_g	$V_{GS} = 10\text{ V}$	$I_D = 11\text{ A}, V_{DS} = 520\text{ V}$	-	71	106	nC
Gate-Source Charge	Q_{gs}			-	14	-	
Gate-Drain Charge	Q_{gd}			-	33	-	
Turn-On Delay Time	$t_{d(on)}$	$V_{DD} = 520\text{ V}, I_D = 11\text{ A},$ $V_{GS} = 10\text{ V}, R_g = 9.1\text{ }\Omega$		-	22	44	ns
Rise Time	t_r			-	34	68	
Turn-Off Delay Time	$t_{d(off)}$			-	68	102	
Fall Time	t_f			-	42	84	
Gate Input Resistance	R_g	$f = 1\text{ MHz}, \text{ open drain}$		-	0.78	-	Ω
Drain-Source Body Diode Characteristics							
Continuous Source-Drain Diode Current	I_S	MOSFET symbol showing the integral reverse p - n junction diode 		-	-	21	A
Pulsed Diode Forward Current	I_{SM}			-	-	53	
Diode Forward Voltage	V_{SD}	$T_J = 25\text{ }^\circ\text{C}, I_S = 11\text{ A}, V_{GS} = 0\text{ V}$		-	0.9	1.2	V
Reverse Recovery Time	t_{rr}	$T_J = 25\text{ }^\circ\text{C}, I_F = I_S = 11\text{ A},$ $di/dt = 100\text{ A}/\mu\text{s}, V_R = 25\text{ V}$		-	160	-	ns
Reverse Recovery Charge	Q_{rr}			-	1.2	-	μC
Reverse Recovery Current	I_{RRM}			-	14	-	A

Notes

- a. $C_{oss(er)}$ is a fixed capacitance that gives the same energy as C_{oss} while V_{DS} is rising from 0 % to 80 % V_{DSS} .
 b. $C_{oss(tr)}$ is a fixed capacitance that gives the same charging time as C_{oss} while V_{DS} is rising from 0 % to 80 % V_{DSS} .

TYPICAL CHARACTERISTICS (25 °C, unless otherwise noted)

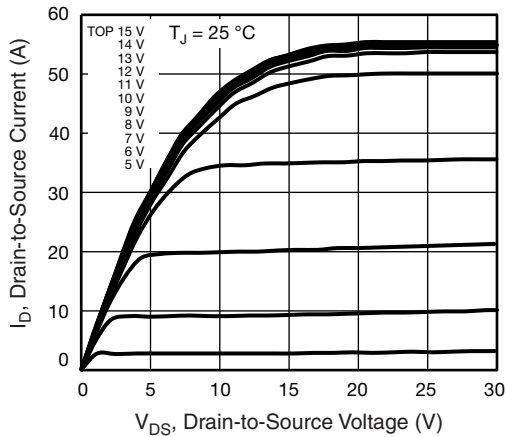

Fig. 1 - Typical Output Characteristics

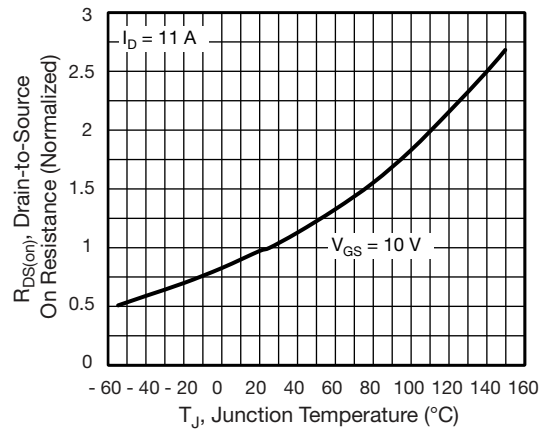

Fig. 4 - Normalized On-Resistance vs. Temperature

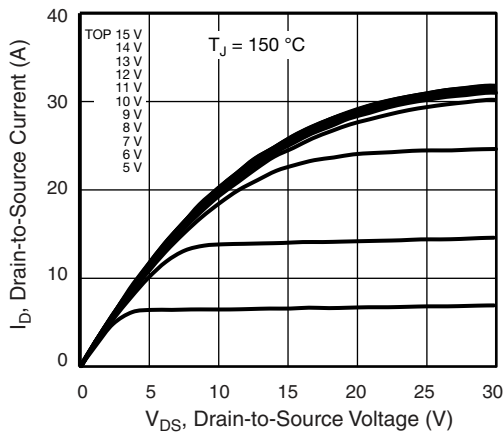

Fig. 2 - Typical Output Characteristics

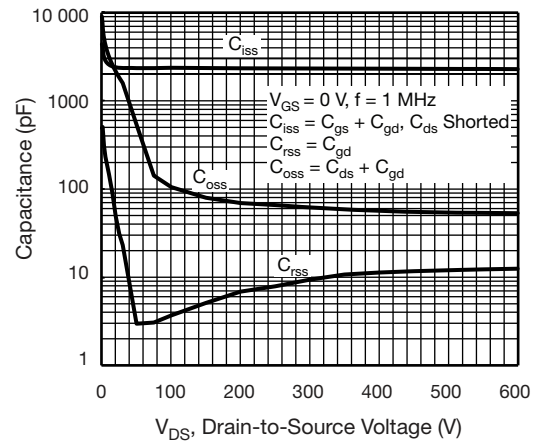

Fig. 5 - Typical Capacitance vs. Drain-to-Source Voltage

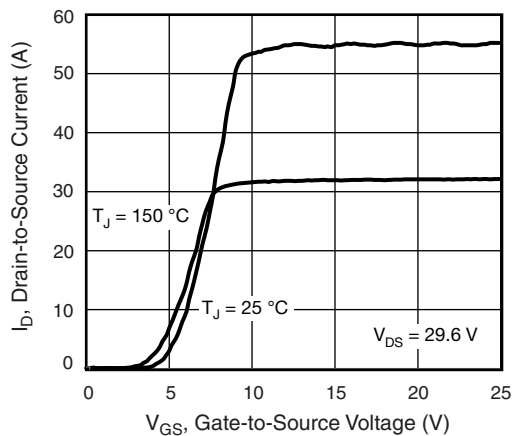

Fig. 3 - Typical Transfer Characteristics

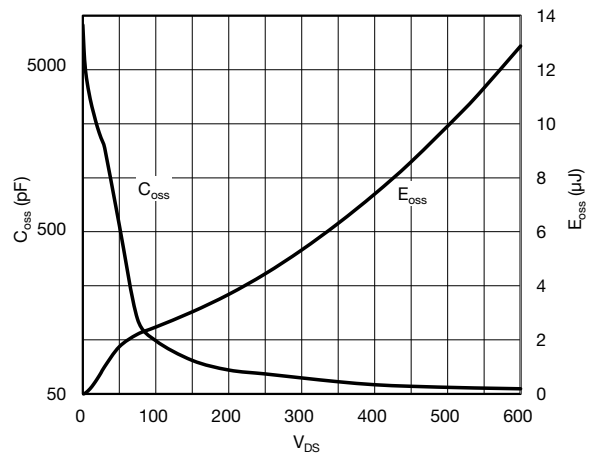

Fig. 6 - C_{oss} and E_{oss} vs. V_{DS}

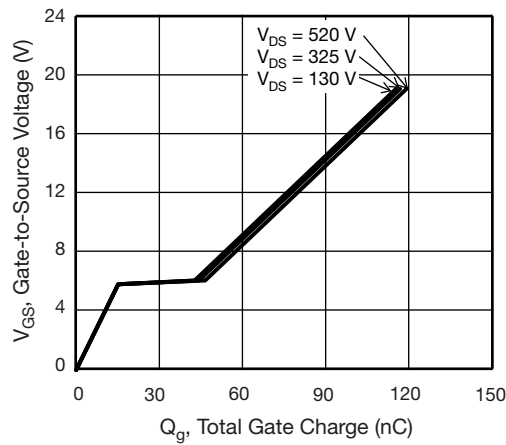

Fig. 7 - Typical Gate Charge vs. Gate-to-Source Voltage

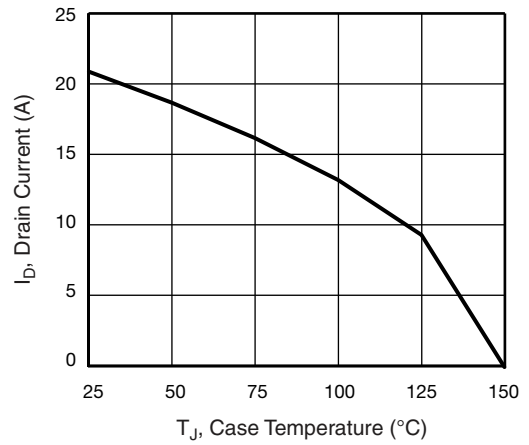

Fig. 10 - Maximum Drain Current vs. Case Temperature

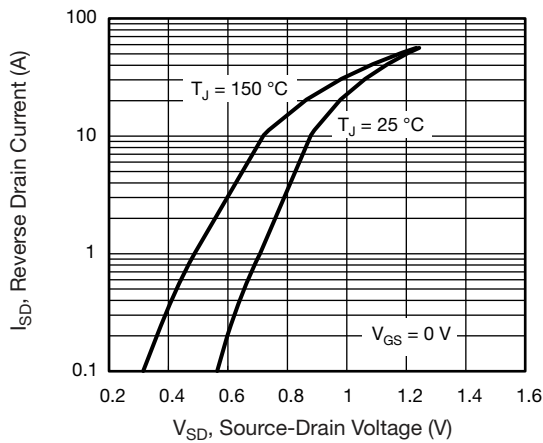

Fig. 8 - Typical Source-Drain Diode Forward Voltage

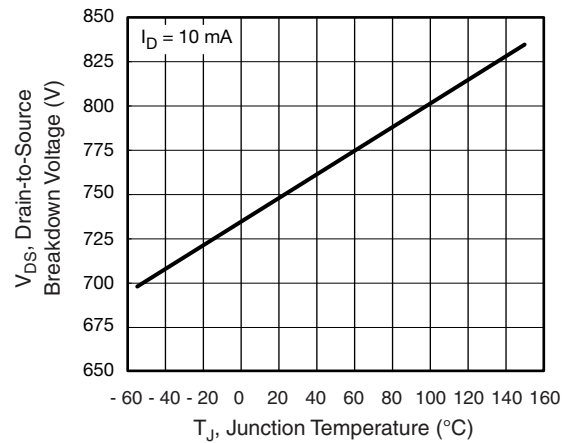

Fig. 11 - Temperature vs. Drain-to-Source Voltage

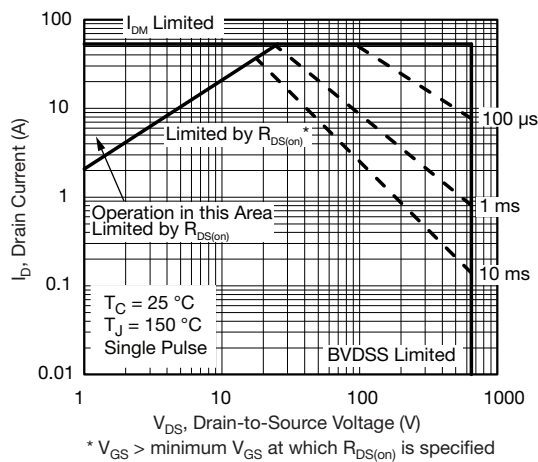

Fig. 9 - Maximum Safe Operating Area

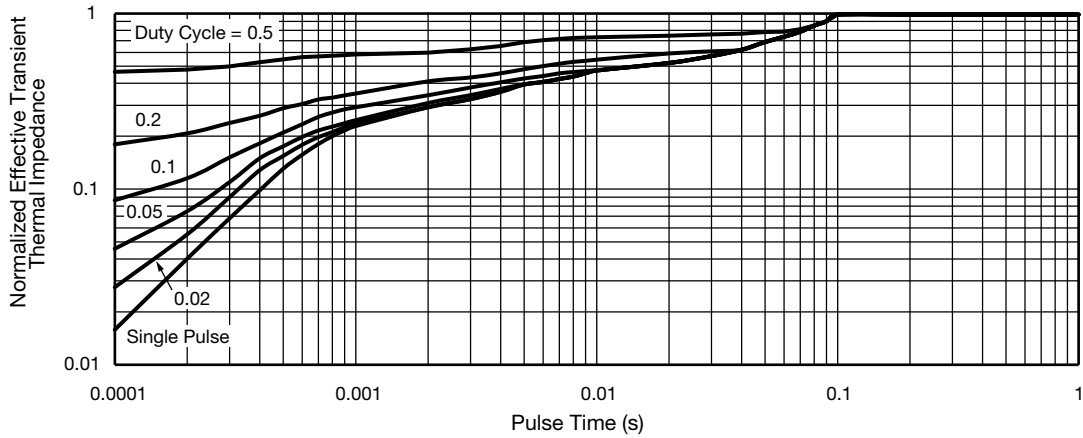

Fig. 12 - Normalized Thermal Transient Impedance, Junction-to-Case



Fig. 13 - Switching Time Test Circuit



Fig. 16 - Unclamped Inductive Waveforms

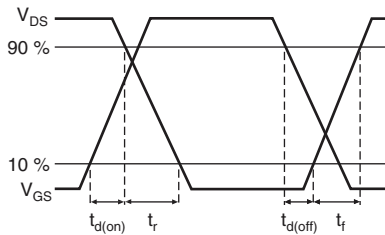

Fig. 14 - Switching Time Waveforms

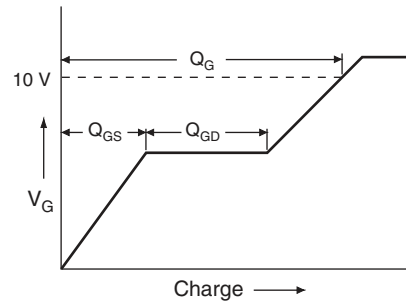

Fig. 17 - Basic Gate Charge Waveform

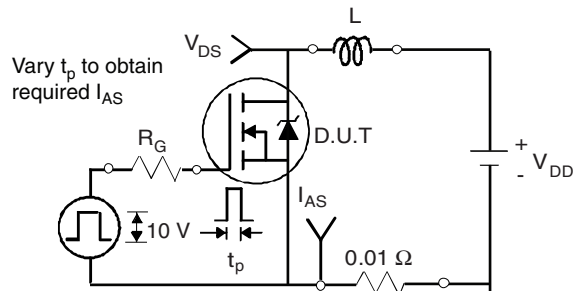

Fig. 15 - Unclamped Inductive Test Circuit

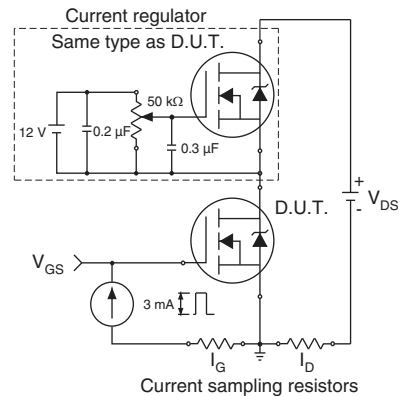

Fig. 18 - Gate Charge Test Circuit

Peak Diode Recovery dV/dt Test Circuit



Note

a. $V_{GS} = 5 V$ for logic level devices

Fig. 19 - For N-Channel

Vishay Siliconix maintains worldwide manufacturing capability. Products may be manufactured at one of several qualified locations. Reliability data for Silicon Technology and Package Reliability represent a composite of all qualified locations. For related documents such as package/tape drawings, part marking, and reliability data, see www.vishay.com/ppg?91607.



Disclaimer

ALL PRODUCT, PRODUCT SPECIFICATIONS AND DATA ARE SUBJECT TO CHANGE WITHOUT NOTICE TO IMPROVE RELIABILITY, FUNCTION OR DESIGN OR OTHERWISE.

Vishay Intertechnology, Inc., its affiliates, agents, and employees, and all persons acting on its or their behalf (collectively, "Vishay"), disclaim any and all liability for any errors, inaccuracies or incompleteness contained in any datasheet or in any other disclosure relating to any product.

Vishay makes no warranty, representation or guarantee regarding the suitability of the products for any particular purpose or the continuing production of any product. To the maximum extent permitted by applicable law, Vishay disclaims (i) any and all liability arising out of the application or use of any product, (ii) any and all liability, including without limitation special, consequential or incidental damages, and (iii) any and all implied warranties, including warranties of fitness for particular purpose, non-infringement and merchantability.

Statements regarding the suitability of products for certain types of applications are based on Vishay's knowledge of typical requirements that are often placed on Vishay products in generic applications. Such statements are not binding statements about the suitability of products for a particular application. It is the customer's responsibility to validate that a particular product with the properties described in the product specification is suitable for use in a particular application. Parameters provided in datasheets and / or specifications may vary in different applications and performance may vary over time. All operating parameters, including typical parameters, must be validated for each customer application by the customer's technical experts. Product specifications do not expand or otherwise modify Vishay's terms and conditions of purchase, including but not limited to the warranty expressed therein.

Except as expressly indicated in writing, Vishay products are not designed for use in medical, life-saving, or life-sustaining applications or for any other application in which the failure of the Vishay product could result in personal injury or death. Customers using or selling Vishay products not expressly indicated for use in such applications do so at their own risk. Please contact authorized Vishay personnel to obtain written terms and conditions regarding products designed for such applications.

No license, express or implied, by estoppel or otherwise, to any intellectual property rights is granted by this document or by any conduct of Vishay. Product names and markings noted herein may be trademarks of their respective owners.

Mouser Electronics

Authorized Distributor

Click to View Pricing, Inventory, Delivery & Lifecycle Information:

Vishay:

[SIHG21N65EF-GE3](#)