

## Small Signal Zener Diodes

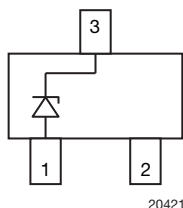

20421

### FEATURES

- Silicon planar Zener diodes
- The Zener voltages are graded according to the international E24 standard. Standard Zener voltage tolerance is  $\pm 5\%$ , indicated by the "C" in the ordering code. Replace "C" with "B" for  $\pm 2\%$  tolerance.
- AEC-Q101 qualified
- ESD capability acc. to AEC-Q101:  
human body model:  $> 8\text{ kV}$ ,  
machine model:  $> 800\text{ V}$
- Base P/N-E3 - RoHS-compliant, commercial grade
- Base P/N-HE3 - RoHS-compliant, AEC-Q101 qualified
- Material categorization: For definitions of compliance please see [www.vishay.com/doc?99912](http://www.vishay.com/doc?99912)

**RoHS**  
COMPLIANT

### PRIMARY CHARACTERISTICS

| PARAMETER             | VALUE         | UNIT |
|-----------------------|---------------|------|
| $V_Z$ range nom.      | 2.4 to 75     | V    |
| Test current $I_{ZT}$ | 2; 5          | mA   |
| $V_Z$ specification   | Pulse current |      |
| Int. construction     | Single        |      |

### ORDERING INFORMATION

| DEVICE NAME  | ORDERING CODE                       | TAPED UNITS PER REEL           | MINIMUM ORDER QUANTITY |
|--------------|-------------------------------------|--------------------------------|------------------------|
| BZX84-series | BZX84C2V4-E3-08 to BZX84C75-E3-08   | 3000 (8 mm tape on 7" reel)    | 15 000                 |
|              | BZX84B2V4-E3-08 to BZX84B75-E3-08   |                                |                        |
|              | BZX84C2V4-HE3-08 to BZX84C75-HE3-08 |                                |                        |
|              | BZX84B2V4-HE3-08 to BZX84B75-HE3-08 |                                |                        |
|              | BZX84C2V4-E3-18 to BZX84C75-E3-18   | 10 000 (8 mm tape on 13" reel) | 10 000                 |
|              | BZX84B2V4-E3-18 to BZX84B75-E3-18   |                                |                        |
|              | BZX84C2V4-HE3-18 to BZX84C75-HE3-18 |                                |                        |
|              | BZX84B2V4-HE3-18 to BZX84B75-HE3-18 |                                |                        |

### PACKAGE

| PACKAGE NAME | WEIGHT | MOLDING COMPOUND FLAMMABILITY RATING | MOISTURE SENSITIVITY LEVEL           | SOLDERING CONDITIONS     |
|--------------|--------|--------------------------------------|--------------------------------------|--------------------------|
| SOT-23       | 8.8 mg | UL 94 V-0                            | MSL level 1<br>(according J-STD-020) | 260 °C/10 s at terminals |

### ABSOLUTE MAXIMUM RATINGS

| PARAMETER                                  | TEST CONDITION   | SYMBOL     | VALUE         | UNIT |
|--|--|------------|---------------|------|
| Power dissipation                          | $T_{amb} = 25\text{ °C}$ , device on fiberglass substrate, acc. layout on page 7 | $P_{tot}$  | 300           | mW   |
| Thermal resistance junction to ambient air | $T_{amb} = 25\text{ °C}$ , device on fiberglass substrate, acc. layout on page 7 | $R_{thJA}$ | 420           | K/W  |
| Junction temperature                       |  | $T_j$      | 150           | °C   |
| Storage temperature range                  |  | $T_{stg}$  | - 65 to + 150 | °C   |
| Operating temperature range                |  | $T_{op}$   | - 55 to + 150 | °C   |



| <b>ELECTRICAL CHARACTERISTICS</b> ( $T_{amb} = 25\text{ }^{\circ}\text{C}$ , unless otherwise specified) |              |                     |      |      |              |           |                         |      |  |                       |                            |      |
|--|--------------|---------------------|------|------|--------------|-----------|-------------------------|------|--|-----------------------|----------------------------|------|
| PART NUMBER  | MARKING CODE | ZENER VOLTAGE RANGE |      |      | TEST CURRENT |           | REVERSE LEAKAGE CURRENT |      | DYNAMIC RESISTANCE<br>$f = 1\text{ kHz}$ |                       | TEMPERATURE COEFFICIENT    |      |
|  |              | $V_Z$ at $I_{ZT1}$  |      |      | $I_{ZT1}$    | $I_{ZT2}$ | $I_R$ at $V_R$          |      | $Z_Z$ at $I_{ZT1}$                       | $Z_{ZK}$ at $I_{ZT2}$ | $\alpha_{VZ}$ at $I_{ZT1}$ |      |
|  |              | V                   |      |      | mA           |           | $\mu\text{A}$           | V    | $\Omega$                                 |                       | $10^{-4}/^{\circ}\text{C}$ |      |
|  |              | MIN.                | NOM. | MAX. |              |           |                         |      | MAX.                                     | MAX.                  | MIN.                       | MAX. |
| BZX84C2V4  | Z11          | 2.2                 | 2.4  | 2.6  | 5            | 1         | 50                      | 1    | 100                                      | 275                   | -9                         | -4   |
| BZX84C2V7  | Z12          | 2.5                 | 2.7  | 2.9  | 5            | 1         | 20                      | 1    | 100                                      | 600                   | -9                         | -4   |
| BZX84C3V0  | Z13          | 2.8                 | 3.0  | 3.2  | 5            | 1         | 10                      | 1    | 95                                       | 600                   | -9                         | -3   |
| BZX84C3V3  | Z14          | 3.1                 | 3.3  | 3.5  | 5            | 1         | 5                       | 1    | 95                                       | 600                   | -8                         | -3   |
| BZX84C3V6  | Z15          | 3.4                 | 3.6  | 3.8  | 5            | 1         | 5                       | 1    | 90                                       | 600                   | -8                         | -3   |
| BZX84C3V9  | Z16          | 3.7                 | 3.9  | 4.1  | 5            | 1         | 3                       | 1    | 90                                       | 600                   | -7                         | -3   |
| BZX84C4V3  | Z17          | 4.0                 | 4.3  | 4.6  | 5            | 1         | 3                       | 1    | 90                                       | 600                   | -6                         | -1   |
| BZX84C4V7  | Z1           | 4.4                 | 4.7  | 5.0  | 5            | 1         | 3                       | 2    | 80                                       | 500                   | -5                         | 2    |
| BZX84C5V1  | Z2           | 4.8                 | 5.1  | 5.4  | 5            | 1         | 2                       | 2    | 60                                       | 480                   | -3                         | 4    |
| BZX84C5V6  | Z3           | 5.2                 | 5.6  | 6.0  | 5            | 1         | 1                       | 2    | 40                                       | 400                   | -2                         | 6    |
| BZX84C6V2  | Z4           | 5.8                 | 6.2  | 6.6  | 5            | 1         | 3                       | 4    | 10                                       | 150                   | -1                         | 7    |
| BZX84C6V8  | Z5           | 6.4                 | 6.8  | 7.2  | 5            | 1         | 2                       | 4    | 15                                       | 80                    | 2                          | 7    |
| BZX84C7V5  | Z6           | 7.0                 | 7.5  | 7.9  | 5            | 1         | 1                       | 5    | 15                                       | 80                    | 3                          | 7    |
| BZX84C8V2  | Z7           | 7.7                 | 8.2  | 8.7  | 5            | 1         | 0.7                     | 5    | 15                                       | 80                    | 4                          | 7    |
| BZX84C9V1  | Z8           | 8.5                 | 9.1  | 9.6  | 5            | 1         | 0.5                     | 6    | 15                                       | 100                   | 5                          | 8    |
| BZX84C10   | Z9           | 9.4                 | 10   | 10.6 | 5            | 1         | 0.2                     | 7    | 20                                       | 150                   | 5                          | 8    |
| BZX84C11   | Y1           | 10.4                | 11   | 11.6 | 5            | 1         | 0.1                     | 8    | 20                                       | 150                   | 5                          | 9    |
| BZX84C12   | Y2           | 11.4                | 12   | 12.7 | 5            | 1         | 0.1                     | 8    | 25                                       | 150                   | 6                          | 9    |
| BZX84C13   | Y3           | 12.4                | 13   | 14.1 | 5            | 1         | 0.1                     | 8    | 30                                       | 170                   | 7                          | 9    |
| BZX84C15   | Y4           | 13.8                | 15   | 15.6 | 5            | 1         | 0.05                    | 10.5 | 30                                       | 200                   | 7                          | 9    |
| BZX84C16   | Y5           | 15.3                | 16   | 17.1 | 5            | 1         | 0.05                    | 11.2 | 40                                       | 200                   | 8                          | 9.5  |
| BZX84C18   | Y6           | 16.8                | 18   | 19.1 | 5            | 1         | 0.05                    | 12.6 | 45                                       | 225                   | 8                          | 9.5  |
| BZX84C20   | Y7           | 18.8                | 20   | 21.2 | 5            | 1         | 0.05                    | 14.0 | 55                                       | 225                   | 8                          | 10   |
| BZX84C22   | Y8           | 20.8                | 22   | 23.3 | 5            | 1         | 0.05                    | 15.4 | 55                                       | 250                   | 8                          | 10   |
| BZX84C24   | Y9           | 22.8                | 24   | 25.6 | 5            | 1         | 0.05                    | 16.8 | 70                                       | 250                   | 8                          | 10   |
| BZX84C27   | Y10          | 25.1                | 27   | 28.9 | 2            | 0.5       | 0.05                    | 18.9 | 80                                       | 300                   | 8                          | 10   |
| BZX84C30   | Y11          | 28                  | 30   | 32   | 2            | 0.5       | 0.05                    | 21.0 | 80                                       | 300                   | 8                          | 10   |
| BZX84C33   | Y12          | 31                  | 33   | 35   | 2            | 0.5       | 0.05                    | 23.1 | 80                                       | 325                   | 8                          | 10   |
| BZX84C36   | Y13          | 34                  | 36   | 38   | 2            | 0.5       | 0.05                    | 25.2 | 90                                       | 350                   | 8                          | 10   |
| BZX84C39   | Y14          | 37                  | 39   | 41   | 2            | 0.5       | 0.05                    | 27.3 | 130                                      | 350                   | 10                         | 12   |
| BZX84C43   | Y15          | 40                  | 43   | 46   | 2            | 0.5       | 0.05                    | 30.1 | 150                                      | 375                   | 10                         | 12   |
| BZX84C47   | Y16          | 44                  | 47   | 50   | 2            | 0.5       | 0.05                    | 32.9 | 170                                      | 375                   | 10                         | 12   |
| BZX84C51   | Y17          | 48                  | 51   | 54   | 2            | 0.5       | 0.05                    | 35.7 | 180                                      | 400                   | 10                         | 12   |
| BZX84C56   | Y18          | 52                  | 56   | 60   | 2            | 0.5       | 0.05                    | 39.2 | 200                                      | 425                   | 9                          | 11   |
| BZX84C62   | Y19          | 58                  | 62   | 66   | 2            | 0.5       | 0.05                    | 43.4 | 215                                      | 450                   | 9                          | 12   |
| BZX84C68   | Y20          | 64                  | 68   | 72   | 2            | 0.5       | 0.05                    | 47.6 | 240                                      | 475                   | 10                         | 12   |
| BZX84C75   | Y21          | 70                  | 75   | 79   | 2            | 0.5       | 0.05                    | 52.5 | 255                                      | 500                   | 10                         | 12   |



| <b>ELECTRICAL CHARACTERISTICS</b> ( $T_{amb} = 25\text{ }^{\circ}\text{C}$ , unless otherwise specified) |              |                     |      |      |              |           |                         |      |  |                       |                            |      |
|--|--------------|---------------------|------|------|--------------|-----------|-------------------------|------|--|-----------------------|----------------------------|------|
| PART NUMBER  | MARKING CODE | ZENER VOLTAGE RANGE |      |      | TEST CURRENT |           | REVERSE LEAKAGE CURRENT |      | DYNAMIC RESISTANCE<br>$f = 1\text{ kHz}$ |                       | TEMPERATURE COEFFICIENT    |      |
|  |              | $V_Z$ at $I_{ZT1}$  |      |      | $I_{ZT1}$    | $I_{ZT2}$ | $I_R$ at $V_R$          |      | $Z_Z$ at $I_{ZT1}$                       | $Z_{ZK}$ at $I_{ZT2}$ | $\alpha_{VZ}$ at $I_{ZT1}$ |      |
|  |              | V                   |      |      | mA           |           | $\mu\text{A}$           | V    | $\Omega$                                 |                       | $10^{-4}/^{\circ}\text{C}$ |      |
|  |              | MIN.                | NOM. | MAX. |              |           |                         |      | MAX.                                     | MAX.                  | MIN.                       | MAX. |
| BZX84B2V4  | Z50          | 2.35                | 2.4  | 2.45 | 5            | 1         | 50                      | 1    | 100                                      | 275                   | -9                         | -4   |
| BZX84B2V7  | Z51          | 2.65                | 2.7  | 2.75 | 5            | 1         | 20                      | 1    | 100                                      | 600                   | -9                         | -4   |
| BZX84B3V0  | Z52          | 2.94                | 3.0  | 3.06 | 5            | 1         | 10                      | 1    | 95                                       | 600                   | -9                         | -3   |
| BZX84B3V3  | Z53          | 3.23                | 3.3  | 3.37 | 5            | 1         | 5                       | 1    | 95                                       | 600                   | -8                         | -3   |
| BZX84B3V6  | Z54          | 3.53                | 3.6  | 3.67 | 5            | 1         | 5                       | 1    | 90                                       | 600                   | -8                         | -3   |
| BZX84B3V9  | Z55          | 3.82                | 3.9  | 3.98 | 5            | 1         | 3                       | 1    | 90                                       | 600                   | -7                         | -3   |
| BZX84B4V3  | Z56          | 4.21                | 4.3  | 4.39 | 5            | 1         | 3                       | 1    | 90                                       | 600                   | -6                         | -1   |
| BZX84B4V7  | Z57          | 4.61                | 4.7  | 4.79 | 5            | 1         | 3                       | 2    | 80                                       | 500                   | -5                         | 2    |
| BZX84B5V1  | Z58          | 5.0                 | 5.1  | 5.2  | 5            | 1         | 2                       | 2    | 60                                       | 480                   | -3                         | 4    |
| BZX84B5V6  | Z59          | 5.49                | 5.6  | 5.71 | 5            | 1         | 1                       | 2    | 40                                       | 400                   | -2                         | 6    |
| BZX84B6V2  | Z60          | 6.08                | 6.2  | 6.32 | 5            | 1         | 3                       | 4    | 10                                       | 150                   | -1                         | 7    |
| BZX84B6V8  | Z61          | 6.66                | 6.8  | 6.94 | 5            | 1         | 2                       | 4    | 15                                       | 80                    | 2                          | 7    |
| BZX84B7V5  | Z62          | 7.35                | 7.5  | 7.65 | 5            | 1         | 1                       | 5    | 15                                       | 80                    | 3                          | 7    |
| BZX84B8V2  | Z63          | 8.04                | 8.2  | 8.36 | 5            | 1         | 0.7                     | 5    | 15                                       | 80                    | 4                          | 7    |
| BZX84B9V1  | Z64          | 8.92                | 9.1  | 9.28 | 5            | 1         | 0.5                     | 6    | 15                                       | 100                   | 5                          | 8    |
| BZX84B10   | Z65          | 9.8                 | 10   | 10.2 | 5            | 1         | 0.2                     | 7    | 20                                       | 150                   | 5                          | 8    |
| BZX84B11   | Z66          | 10.8                | 11   | 11.2 | 5            | 1         | 0.1                     | 8    | 20                                       | 150                   | 5                          | 9    |
| BZX84B12   | Z67          | 11.8                | 12   | 12.2 | 5            | 1         | 0.1                     | 8    | 25                                       | 150                   | 6                          | 9    |
| BZX84B13   | Z68          | 12.7                | 13   | 13.3 | 5            | 1         | 0.1                     | 8    | 30                                       | 170                   | 7                          | 9    |
| BZX84B15   | Z69          | 14.7                | 15   | 15.3 | 5            | 1         | 0.05                    | 10.5 | 30                                       | 200                   | 7                          | 9    |
| BZX84B16   | Z70          | 15.7                | 16   | 16.3 | 5            | 1         | 0.05                    | 11.2 | 40                                       | 200                   | 8                          | 9.5  |
| BZX84B18   | Z71          | 17.6                | 18   | 18.4 | 5            | 1         | 0.05                    | 12.6 | 45                                       | 225                   | 8                          | 9.5  |
| BZX84B20   | Z72          | 19.6                | 20   | 20.4 | 5            | 1         | 0.05                    | 14   | 55                                       | 225                   | 8                          | 10   |
| BZX84B22   | Z73          | 21.6                | 22   | 22.4 | 5            | 1         | 0.05                    | 15.4 | 55                                       | 250                   | 8                          | 10   |
| BZX84B24   | Z74          | 23.5                | 24   | 24.5 | 5            | 1         | 0.05                    | 16.8 | 70                                       | 250                   | 8                          | 10   |
| BZX84B27   | Z75          | 26.5                | 27   | 27.5 | 2            | 0.5       | 0.05                    | 18.9 | 80                                       | 300                   | 8                          | 10   |
| BZX84B30   | Z76          | 29.4                | 30   | 30.6 | 2            | 0.5       | 0.05                    | 21   | 80                                       | 300                   | 8                          | 10   |
| BZX84B33   | Z77          | 32.3                | 33   | 33.7 | 2            | 0.5       | 0.05                    | 23.1 | 80                                       | 325                   | 8                          | 10   |
| BZX84B36   | Z78          | 35.3                | 36   | 36.7 | 2            | 0.5       | 0.05                    | 25.2 | 90                                       | 350                   | 8                          | 10   |
| BZX84B39   | Z79          | 38.2                | 39   | 39.8 | 2            | 0.5       | 0.05                    | 27.3 | 130                                      | 350                   | 10                         | 12   |
| BZX84B43   | Z80          | 42.1                | 43   | 43.9 | 2            | 0.5       | 0.05                    | 30.1 | 150                                      | 375                   | 10                         | 12   |
| BZX84B47   | Z81          | 46.1                | 47   | 47.9 | 2            | 0.5       | 0.05                    | 32.9 | 170                                      | 375                   | 10                         | 12   |
| BZX84B51   | Z82          | 50                  | 51   | 52   | 2            | 0.5       | 0.05                    | 35.7 | 180                                      | 400                   | 10                         | 12   |
| BZX84B56   | Z83          | 54.9                | 56   | 57.1 | 2            | 0.5       | 0.05                    | 39.2 | 200                                      | 425                   | 9                          | 11   |
| BZX84B62   | Z84          | 60.8                | 62   | 63.2 | 2            | 0.5       | 0.05                    | 43.4 | 215                                      | 450                   | 9                          | 12   |
| BZX84B68   | Z85          | 66.6                | 68   | 69.4 | 2            | 0.5       | 0.05                    | 47.6 | 240                                      | 475                   | 10                         | 12   |
| BZX84B75   | Z86          | 73.5                | 75   | 76.5 | 2            | 0.5       | 0.05                    | 52.5 | 255                                      | 500                   | 10                         | 12   |

**TYPICAL CHARACTERISTICS** ( $T_{amb} = 25\text{ }^{\circ}\text{C}$ , unless otherwise specified)

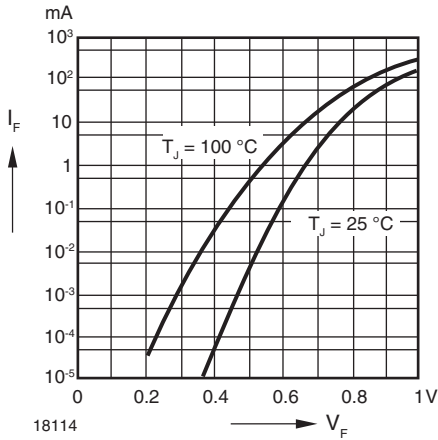

Fig. 1 - Forward Characteristics

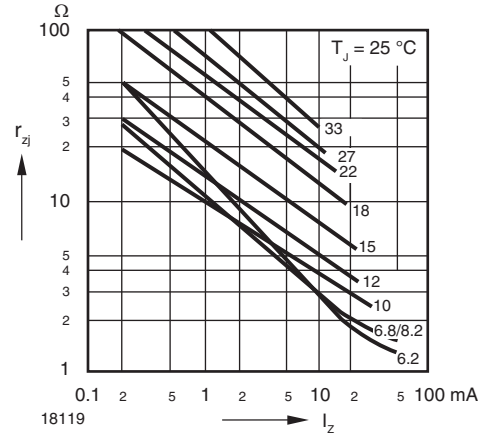

Fig. 4 - Dynamic Resistance vs. Zener Current

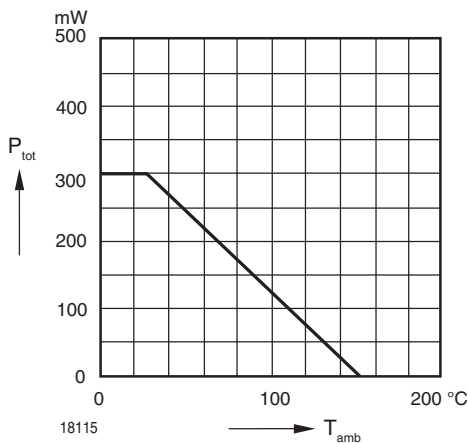

Fig. 2 - Admissible Power Dissipation vs. Ambient Temperature

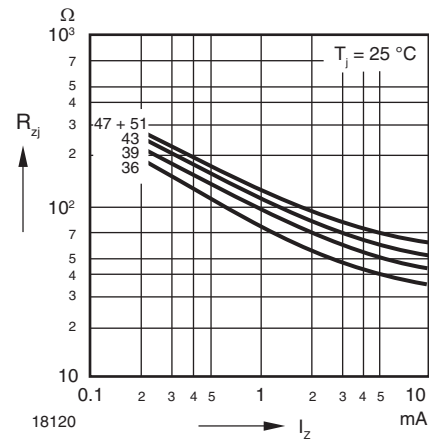

Fig. 5 - Dynamic Resistance vs. Zener Current

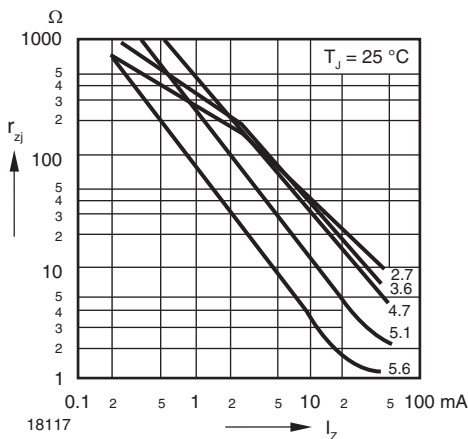

Fig. 3 - Dynamic Resistance vs. Zener Current

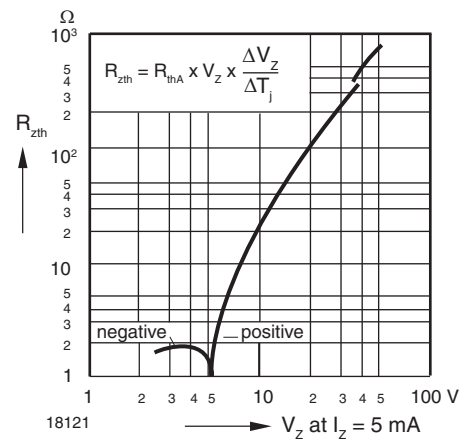

Fig. 6 - Thermal Differential Resistance vs. Zener Voltage

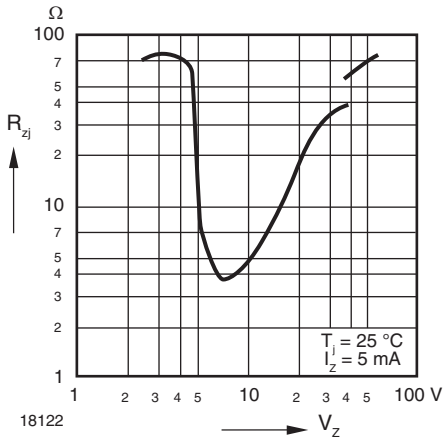

Fig. 7 - Dynamic Resistance vs. Zener Voltage

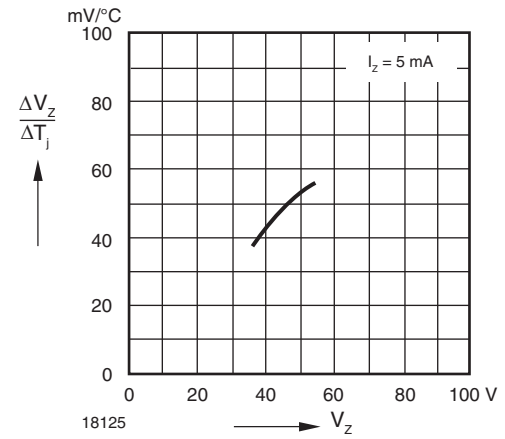

Fig. 10 - Temperature Dependence of Zener Voltage vs. Zener Voltage

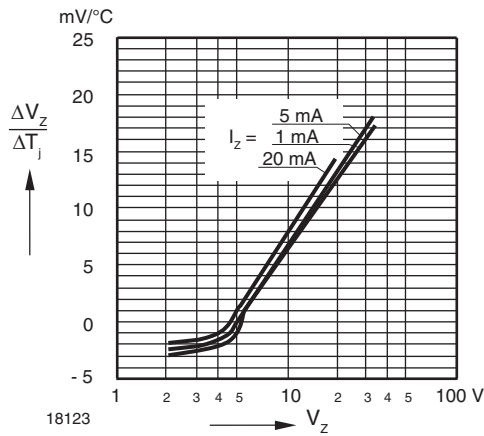

Fig. 8 - Temperature Dependence of Zener Voltage vs. Zener Voltage

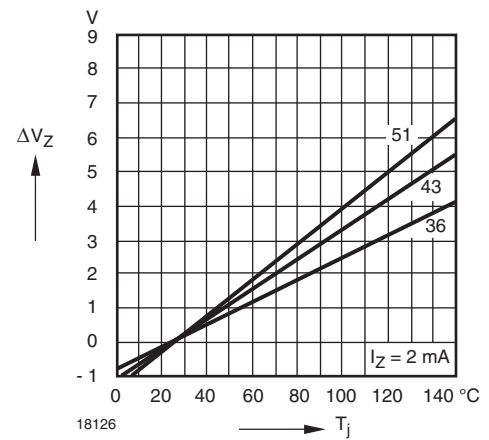

Fig. 11 - Change of Zener Voltage vs. Junction Temperature

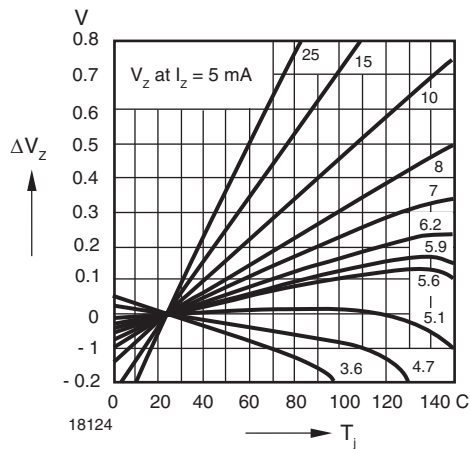

Fig. 9 - Change of Zener Voltage vs. Junction Temperature

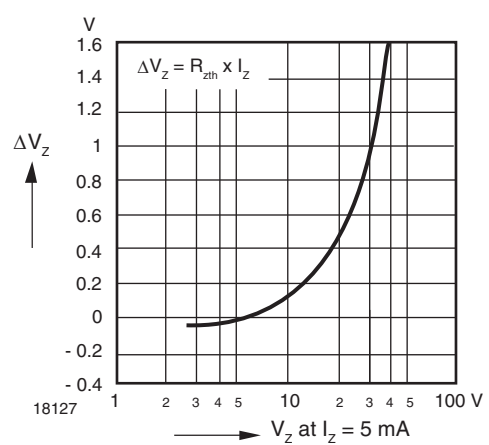

Fig. 12 - Change of Zener Voltage from Turn-on up to the Point of Thermal Equilibrium vs. Zener Voltage

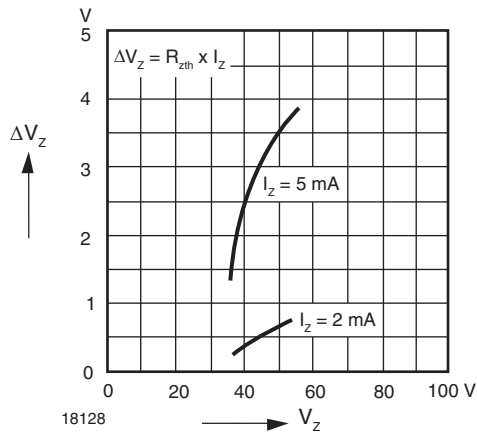

Fig. 13 - Change of Zener Voltage from Turn-on up to the Point of Thermal Equilibrium vs. Zener Voltage

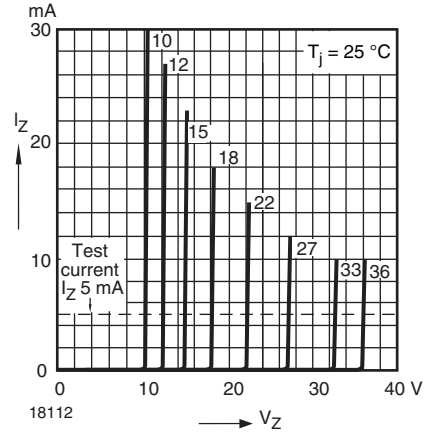

Fig. 15 - Breakdown Characteristics

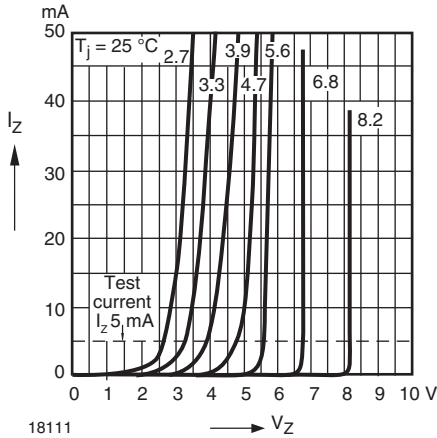

Fig. 14 - Breakdown Characteristics

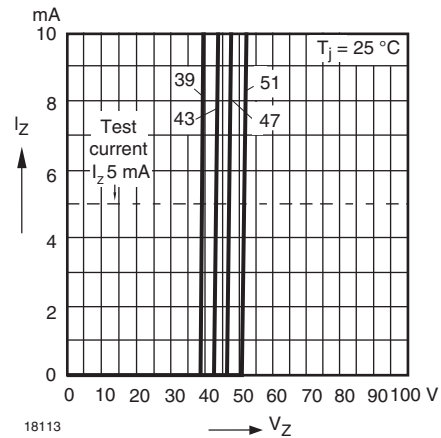
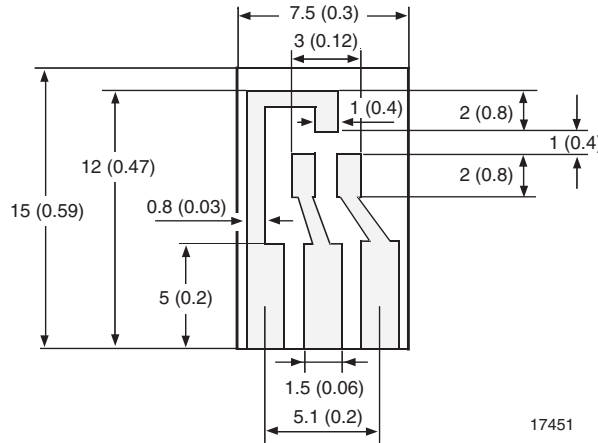

Fig. 16 - Breakdown Characteristics

**LAYOUT FOR  $R_{thJA}$  TEST**

Thickness: fiberglass 0.059" (1.5 mm)  
Copper leads 0.012" (0.3 mm)



**PACKAGE DIMENSIONS** in millimeters (inches): **SOT-23**

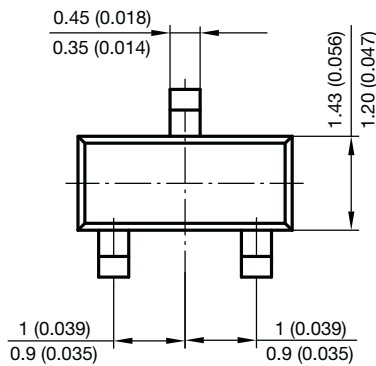
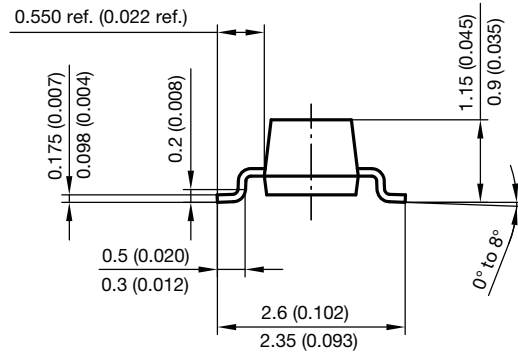
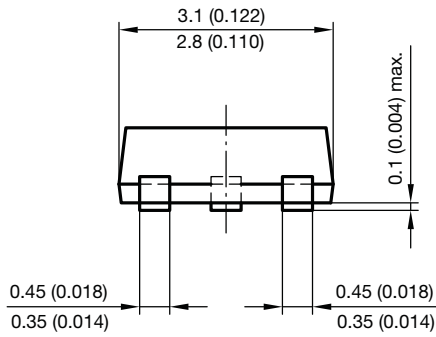

Foot print recommendation:

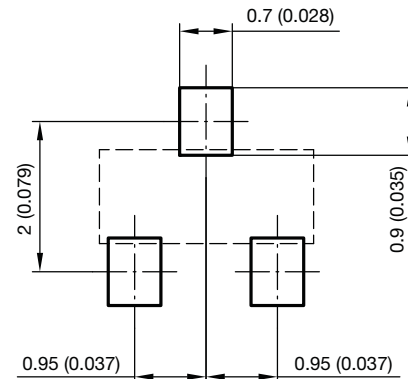

Document no.: 6.541-5014.01-4  
Rev. 8 - Date: 23.Sept.2009  
17418



## **Disclaimer**

ALL PRODUCT, PRODUCT SPECIFICATIONS AND DATA ARE SUBJECT TO CHANGE WITHOUT NOTICE TO IMPROVE RELIABILITY, FUNCTION OR DESIGN OR OTHERWISE.

Vishay Intertechnology, Inc., its affiliates, agents, and employees, and all persons acting on its or their behalf (collectively, "Vishay"), disclaim any and all liability for any errors, inaccuracies or incompleteness contained in any datasheet or in any other disclosure relating to any product.

Vishay makes no warranty, representation or guarantee regarding the suitability of the products for any particular purpose or the continuing production of any product. To the maximum extent permitted by applicable law, Vishay disclaims (i) any and all liability arising out of the application or use of any product, (ii) any and all liability, including without limitation special, consequential or incidental damages, and (iii) any and all implied warranties, including warranties of fitness for particular purpose, non-infringement and merchantability.

Statements regarding the suitability of products for certain types of applications are based on Vishay's knowledge of typical requirements that are often placed on Vishay products in generic applications. Such statements are not binding statements about the suitability of products for a particular application. It is the customer's responsibility to validate that a particular product with the properties described in the product specification is suitable for use in a particular application. Parameters provided in datasheets and / or specifications may vary in different applications and performance may vary over time. All operating parameters, including typical parameters, must be validated for each customer application by the customer's technical experts. Product specifications do not expand or otherwise modify Vishay's terms and conditions of purchase, including but not limited to the warranty expressed therein.

Except as expressly indicated in writing, Vishay products are not designed for use in medical, life-saving, or life-sustaining applications or for any other application in which the failure of the Vishay product could result in personal injury or death. Customers using or selling Vishay products not expressly indicated for use in such applications do so at their own risk. Please contact authorized Vishay personnel to obtain written terms and conditions regarding products designed for such applications.

No license, express or implied, by estoppel or otherwise, to any intellectual property rights is granted by this document or by any conduct of Vishay. Product names and markings noted herein may be trademarks of their respective owners.



# Mouser Electronics

Authorized Distributor

Click to View Pricing, Inventory, Delivery & Lifecycle Information:

## Vishay:

[BZX84C30-V-GS08](#) [BZX84C36-V-GS08](#) [BZX84C5V1-V-GS08](#) [BZX84C7V5-V-GS08](#) [BZX84C3V0-V-GS08](#)  
[BZX84C11-V-GS08](#) [BZX84C10-V-GS08](#) [BZX84C16-V-GS08](#) [BZX84C27-V-GS08](#) [BZX84C13-V-GS08](#) [BZX84C4V3-V-GS08](#)  
[BZX84C9V1-V-GS08](#) [BZX84C22-V-GS08](#) [BZX84C39-V-GS08](#) [BZX84C15-V-GS08](#) [BZX84C2V7-V-GS08](#)  
[BZX84C33-V-GS08](#) [BZX84C68-V-GS08](#) [BZX84C43-V-GS08](#) [BZX84C5V6-V-GS08](#) [BZX84C6V8-V-GS08](#)  
[BZX84C2V4-V-GS08](#) [BZX84C4V7-V-GS08](#) [BZX84B6V2-V-GS08](#) [BZX84C12-V-GS08](#) [BZX84C24-V-GS08](#)  
[BZX84C51-V-GS08](#) [BZX84C47-V-GS08](#) [BZX84C3V3-V-GS08](#) [BZX84C8V2-V-GS08](#) [BZX84C3V6-V-GS08](#)  
[BZX84C6V2-V-GS08](#) [BZX84C18-V-GS08](#) [BZX84C3V9-V-GS08](#) [BZX84C20-V-GS08](#) [BZX84B10-V-GS08](#) [BZX84B11-V-GS08](#)  
[BZX84B12-V-GS08](#) [BZX84B13-V-GS08](#) [BZX84B15-V-GS08](#) [BZX84B16-V-GS08](#) [BZX84B18-V-GS08](#)  
[BZX84B2V4-V-GS08](#) [BZX84B2V7-V-GS08](#) [BZX84B20-V-GS08](#) [BZX84B22-V-GS08](#) [BZX84B24-V-GS08](#) [BZX84B27-V-GS08](#)  
[BZX84B3V0-V-GS08](#) [BZX84B3V3-V-GS08](#) [BZX84B3V6-V-GS08](#) [BZX84B3V9-V-GS08](#) [BZX84B30-V-GS08](#)  
[BZX84B33-V-GS08](#) [BZX84B36-V-GS08](#) [BZX84B39-V-GS08](#) [BZX84B4V3-V-GS08](#) [BZX84B4V7-V-GS08](#) [BZX84B47-V-GS08](#)  
[BZX84B5V1-V-GS08](#) [BZX84B5V6-V-GS08](#) [BZX84B56-V-GS08](#) [BZX84B6V8-V-GS08](#) [BZX84B62-V-GS08](#)  
[BZX84B7V5-V-GS08](#) [BZX84B75-V-GS08](#) [BZX84B8V2-V-GS08](#) [BZX84B9V1-V-GS08](#) [BZX84C56-V-GS08](#)  
[BZX84C62-V-GS08](#) [BZX84C75-V-GS08](#) [BZX84B10-V-GS18](#) [BZX84B11-V-GS18](#) [BZX84B12-V-GS18](#) [BZX84B13-V-GS18](#)  
[BZX84B15-V-GS18](#) [BZX84B16-V-GS18](#) [BZX84B18-V-GS18](#) [BZX84B2V4-V-GS18](#) [BZX84B2V7-V-GS18](#)  
[BZX84B20-V-GS18](#) [BZX84B22-V-GS18](#) [BZX84B24-V-GS18](#) [BZX84B27-V-GS18](#) [BZX84B3V0-V-GS18](#) [BZX84B3V3-V-GS18](#)  
[BZX84B3V6-V-GS18](#) [BZX84B3V9-V-GS18](#) [BZX84B30-V-GS18](#) [BZX84B33-V-GS18](#) [BZX84B36-V-GS18](#)  
[BZX84B39-V-GS18](#) [BZX84B4V3-V-GS18](#) [BZX84B4V7-V-GS18](#) [BZX84B47-V-GS18](#) [BZX84B5V1-V-GS18](#)  
[BZX84B5V6-V-GS18](#) [BZX84B56-V-GS18](#) [BZX84B6V2-V-GS18](#) [BZX84B6V8-V-GS18](#)