

Automotive Dual N-Channel 60 V (D-S) 175 °C MOSFET

PRODUCT SUMMARY	
V_{DS} (V)	60
$R_{DS(on)}$ (Ω) at $V_{GS} = 10$ V	0.064
$R_{DS(on)}$ (Ω) at $V_{GS} = 4.5$ V	0.082
I_D (A) per leg	6
Configuration	Dual
Package	SO-8

FEATURES

- TrenchFET® power MOSFET
- 100 % R_g and UIS tested
- AEC-Q101 qualified
- Material categorization: for definitions of compliance please see www.vishay.com/doc?99912

 AUTOMOTIVE
GRADE

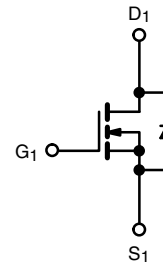
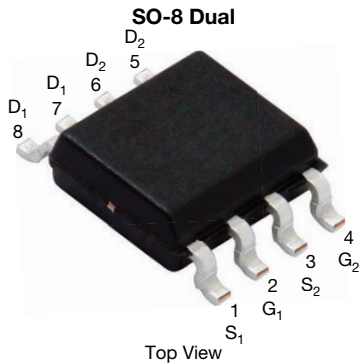
RoHS
COMPLIANT
HALOGEN
FREE

N-Channel MOSFET

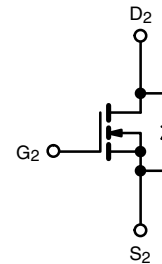

N-Channel MOSFET

ABSOLUTE MAXIMUM RATINGS ($T_C = 25$ °C, unless otherwise noted)				
PARAMETER		SYMBOL	LIMIT	UNIT
Drain-Source Voltage		V_{DS}	60	V
Gate-Source Voltage		V_{GS}	± 20	
Continuous Drain Current	$T_C = 25$ °C	I_D	5.4	A
	$T_C = 125$ °C		3.1	
Continuous Source Current (Diode Conduction) ^a		I_S	3.6	
Pulsed Drain Current ^b		I_{DM}	21.5	
Single Pulse Avalanche Current	L = 0.1 mH	I_{AS}	8.5	
Single Pulse Avalanche Energy		E_{AS}	3.6	
Maximum Power Dissipation ^b	$T_C = 25$ °C	P_D	4	W
	$T_C = 125$ °C		1.3	
Operating Junction and Storage Temperature Range		T_J, T_{stg}	-55 to +175	°C

THERMAL RESISTANCE RATINGS				
PARAMETER		SYMBOL	LIMIT	UNIT
Junction-to-Ambient	PCB Mount ^c	R_{thJA}	112	°C/W
Junction-to-Foot (Drain)		R_{thJF}	38	

Notes

- Package limited.
- Pulse test; pulse width ≤ 300 μ s, duty cycle ≤ 2 %.
- When mounted on 1" square PCB (FR4 material).



SPECIFICATIONS ($T_C = 25\text{ }^\circ\text{C}$, unless otherwise noted)							
PARAMETER	SYMBOL	TEST CONDITIONS		MIN.	TYP.	MAX.	UNIT
Static							
Drain-Source Breakdown Voltage	V_{DS}	$V_{GS} = 0\text{ V}$, $I_D = 250\text{ }\mu\text{A}$		60	-	-	V
Gate-Source Threshold Voltage	$V_{GS(th)}$	$V_{DS} = V_{GS}$, $I_D = 250\text{ }\mu\text{A}$		1.5	2	2.5	
Gate-Source Leakage	I_{GSS}	$V_{DS} = 0\text{ V}$, $V_{GS} = \pm 20\text{ V}$		-	-	± 100	nA
Zero Gate Voltage Drain Current	I_{DSS}	$V_{GS} = 0\text{ V}$	$V_{DS} = 60\text{ V}$	-	-	1	μA
		$V_{GS} = 0\text{ V}$	$V_{DS} = 60\text{ V}$, $T_J = 125\text{ }^\circ\text{C}$	-	-	50	
		$V_{GS} = 0\text{ V}$	$V_{DS} = 60\text{ V}$, $T_J = 175\text{ }^\circ\text{C}$	-	-	150	
On-State Drain Current ^a	$I_{D(on)}$	$V_{GS} = 10\text{ V}$	$V_{DS} \geq 5\text{ V}$	20	-	-	A
Drain-Source On-State Resistance ^a	$R_{DS(on)}$	$V_{GS} = 10\text{ V}$	$I_D = 3.4\text{ A}$	-	0.045	0.064	Ω
		$V_{GS} = 10\text{ V}$	$I_D = 3.4\text{ A}$, $T_J = 125\text{ }^\circ\text{C}$	-	-	0.110	
		$V_{GS} = 10\text{ V}$	$I_D = 3.4\text{ A}$, $T_J = 175\text{ }^\circ\text{C}$	-	-	0.137	
		$V_{GS} = 4.5\text{ V}$	$I_D = 3.7\text{ A}$	-	0.060	0.082	
Forward Transconductance ^f	g_{fs}	$V_{DS} = 15\text{ V}$, $I_D = 3.7\text{ A}$		-	12	-	S
Dynamic ^b							
Input Capacitance	C_{iss}	$V_{GS} = 0\text{ V}$	$V_{DS} = 25\text{ V}$, $f = 1\text{ MHz}$	-	375	470	pF
Output Capacitance	C_{oss}			-	70	88	
Reverse Transfer Capacitance	C_{rss}			-	30	36	
Total Gate Charge ^c	Q_g	$V_{GS} = 10\text{ V}$	$V_{DS} = 30\text{ V}$, $I_D = 4.3\text{ A}$	-	8	12	nC
Gate-Source Charge ^c	Q_{gs}			-	1.2	1.5	
Gate-Drain Charge ^c	Q_{gd}			-	1.7	2.6	
Gate Resistance	R_g	$f = 1\text{ MHz}$		1.1	-	6.66	Ω
Turn-On Delay Time ^c	$t_{d(on)}$	$V_{DD} = 30\text{ V}$, $R_L = 8.8\text{ }\Omega$ $I_D \cong 3.4\text{ A}$, $V_{GEN} = 10\text{ V}$, $R_g = 1\text{ }\Omega$		-	6	9	ns
Rise Time ^c	t_r			-	2.8	4.2	
Turn-Off Delay Time ^c	$t_{d(off)}$			-	17	26	
Fall Time ^c	t_f			-	1.7	3	
Source-Drain Diode Ratings and Characteristics ^b							
Pulsed Current ^a	I_{SM}			-	-	21.5	A
Forward Voltage	V_{SD}	$I_F = 2\text{ A}$, $V_{GS} = 0\text{ V}$		-	0.75	1.1	V

Notes

- Pulse test; pulse width $\leq 300\text{ }\mu\text{s}$, duty cycle $\leq 2\%$.
- Guaranteed by design, not subject to production testing.
- Independent of operating temperature.

Stresses beyond those listed under "Absolute Maximum Ratings" may cause permanent damage to the device. These are stress ratings only, and functional operation of the device at these or any other conditions beyond those indicated in the operational sections of the specifications is not implied. Exposure to absolute maximum rating conditions for extended periods may affect device reliability.



TYPICAL CHARACTERISTICS (T_A = 25 °C, unless otherwise noted)

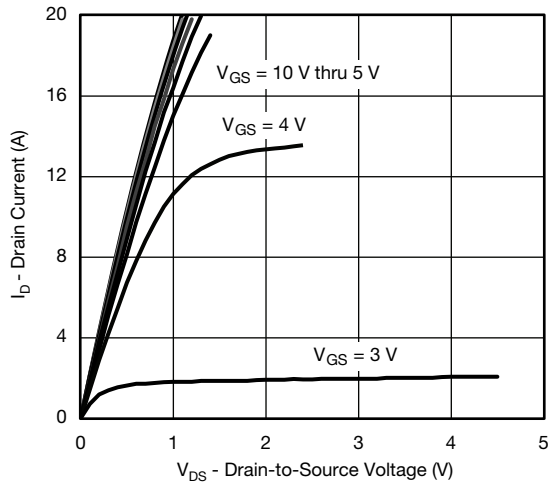

Output Characteristics

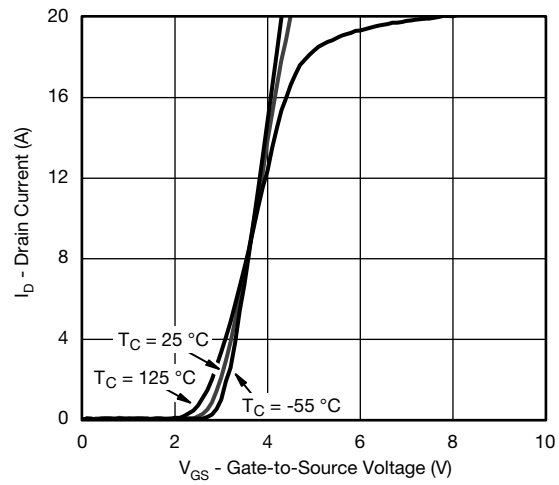

Transfer Characteristics

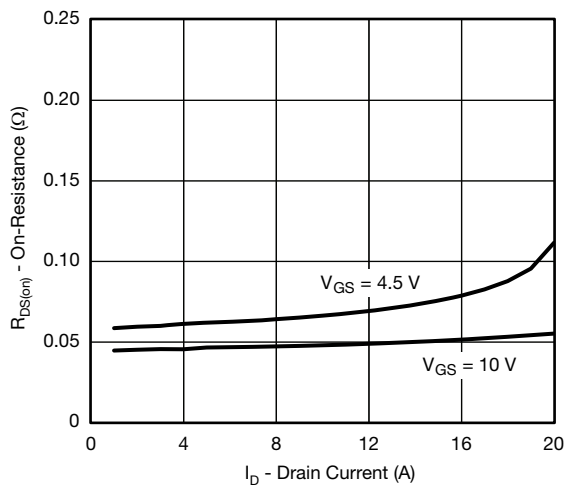

On-Resistance vs. Drain Current

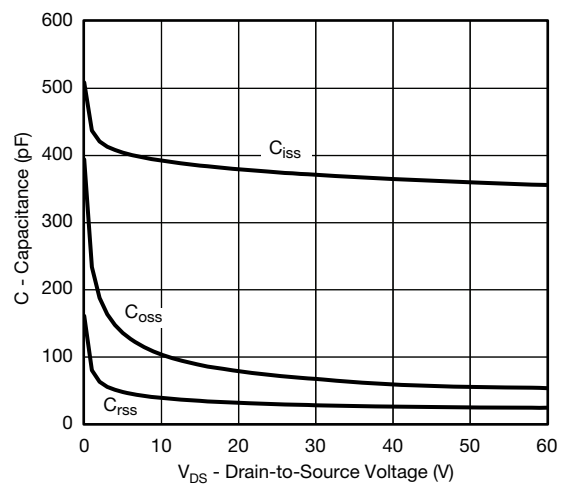

Capacitance

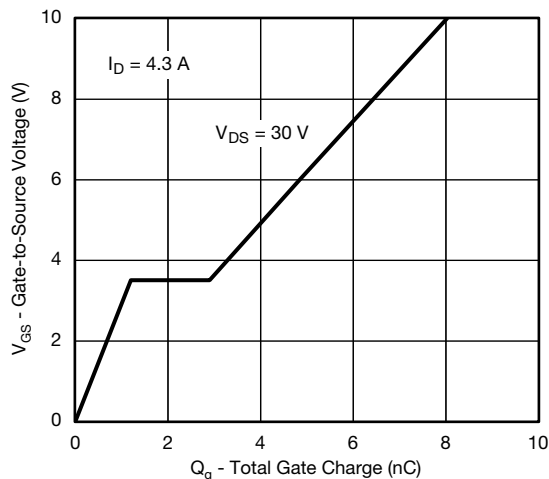

Gate Charge

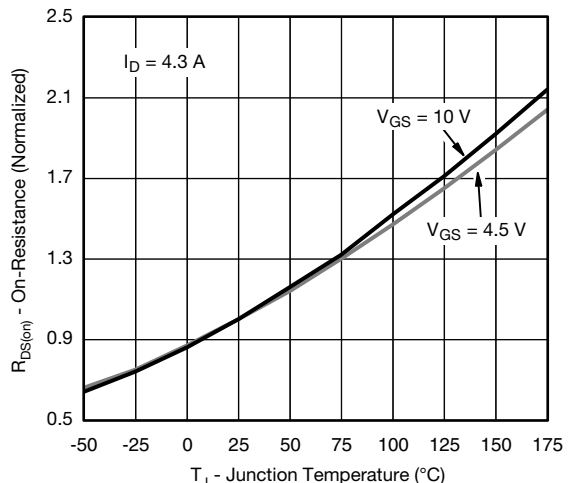

On-Resistance vs. Junction Temperature



TYPICAL CHARACTERISTICS (T_A = 25 °C, unless otherwise noted)

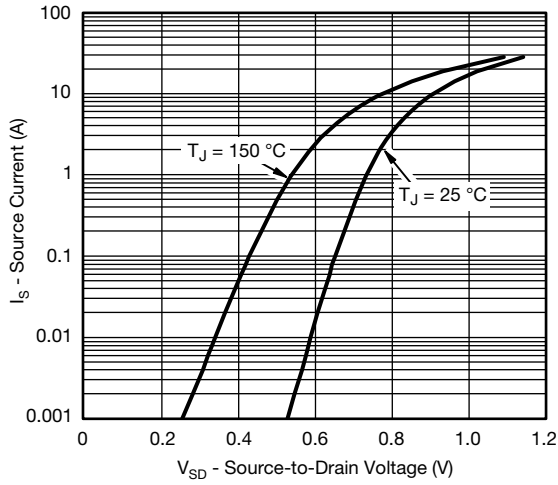

Source Drain Diode Forward Voltage

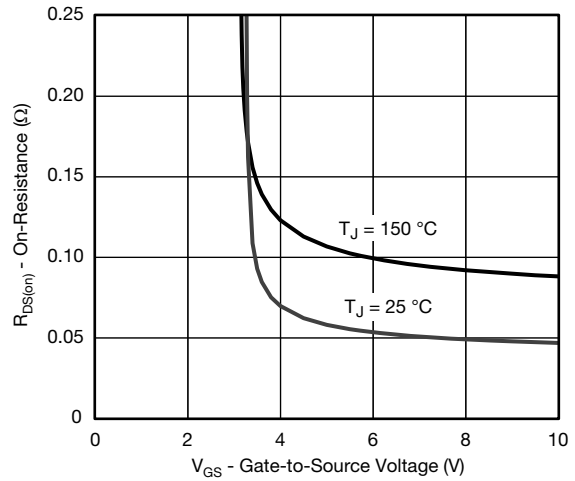

On-Resistance vs. Gate-to-Source Voltage

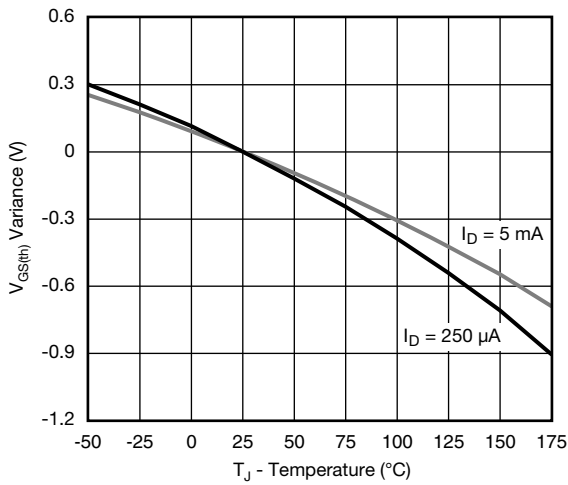

Threshold Voltage

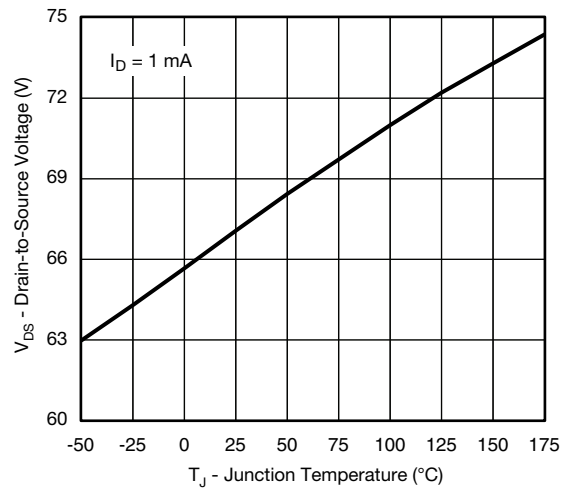

Drain Source Breakdown vs. Junction Temperature

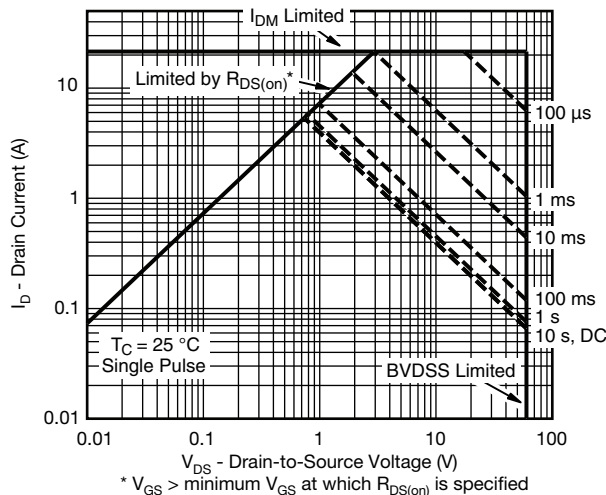

Safe Operating Area



THERMAL RATINGS ($T_A = 25\text{ }^\circ\text{C}$, unless otherwise noted)

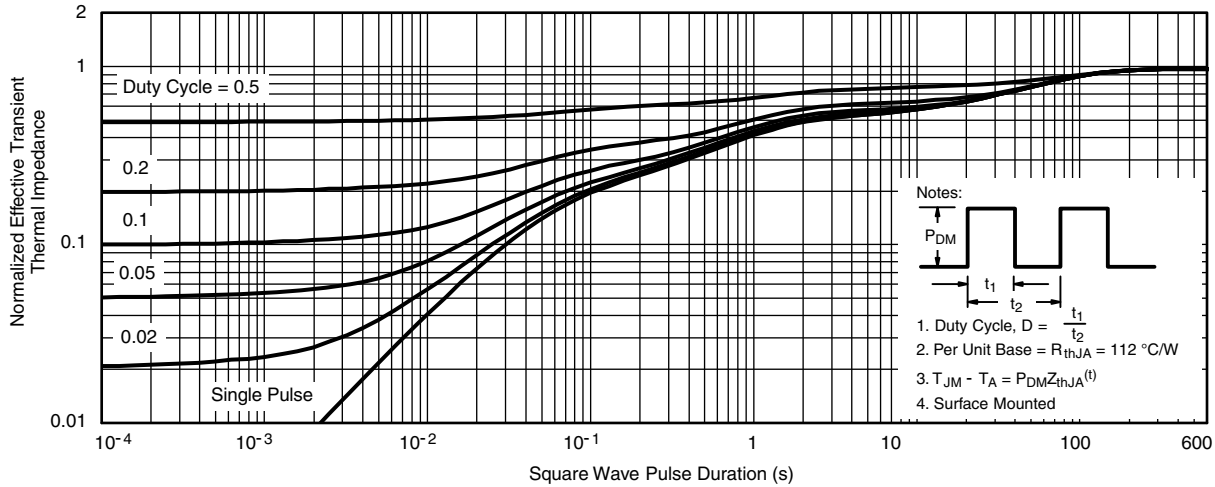

Normalized Thermal Transient Impedance, Junction-to-Ambient

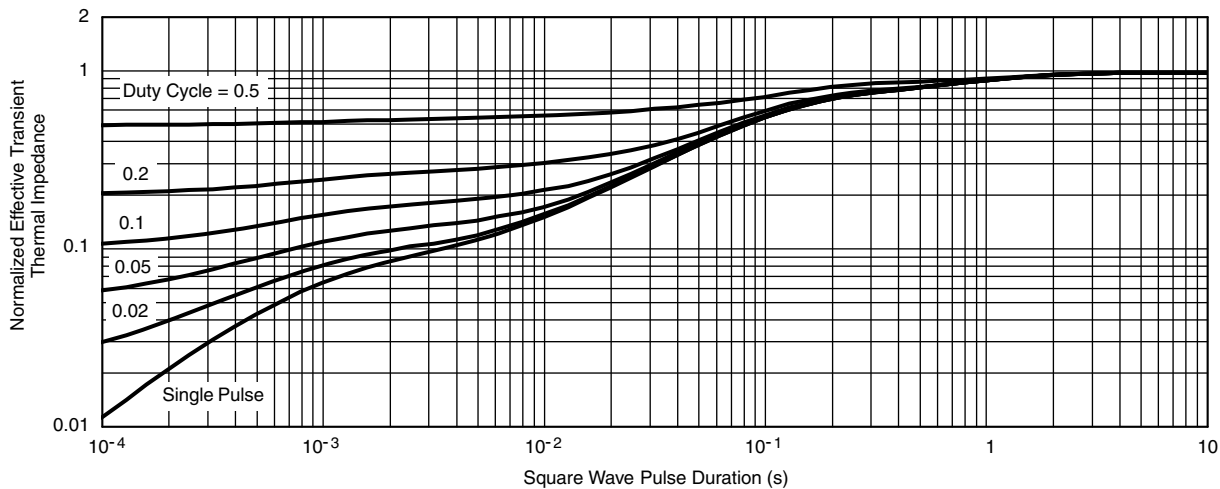

Normalized Thermal Transient Impedance, Junction-to-Foot

Note

- The characteristics shown in the two graphs
 - Normalized Transient Thermal Impedance Junction-to-Ambient ($25\text{ }^\circ\text{C}$)
 - Normalized Transient Thermal Impedance Junction-to-Foot ($25\text{ }^\circ\text{C}$)
- are given for general guidelines only to enable the user to get a “ball park” indication of part capabilities. The data are extracted from single pulse transient thermal impedance characteristics which are developed from empirical measurements. The latter is valid for the part mounted on printed circuit board - FR4, size 1" x 1" x 0.062", double sided with 2 oz. copper, 100 % on both sides. The part capabilities can widely vary depending on actual application parameters and operating conditions.

Vishay Siliconix maintains worldwide manufacturing capability. Products may be manufactured at one of several qualified locations. Reliability data for Silicon Technology and Package Reliability represent a composite of all qualified locations. For related documents such as package/tape drawings, part marking, and reliability data, see www.vishay.com/ppg?71504.



REVISION HISTORY ^a		
REVISION	DATE	DESCRIPTION OF CHANGE
D	04-Aug-15	• Revised R _g minimum limit

Note

a. As of April 2014



SO-8

Ordering codes for the SQ rugged series power MOSFETs in the SO-8 package:

DATASHEET PART NUMBER	OLD ORDERING CODE ^a	NEW ORDERING CODE
SQ4005EY	-	SQ4005EY-T1_GE3
SQ4050EY	SQ4050EY-T1-GE3	SQ4050EY-T1_GE3
SQ4182EY	SQ4182EY-T1-GE3	SQ4182EY-T1_GE3
SQ4184EY	SQ4184EY-T1-GE3	SQ4184EY-T1_GE3
SQ4282EY	SQ4282EY-T1-GE3	SQ4282EY-T1_GE3
SQ4284EY	SQ4284EY-T1-GE3	SQ4284EY-T1_GE3
SQ4401EY	SQ4401EY-T1-GE3	SQ4401EY-T1_GE3
SQ4410EY	SQ4410EY-T1-GE3	SQ4410EY-T1_GE3
SQ4425EY	SQ4425EY-T1-GE3	SQ4425EY-T1_GE3
SQ4431EY	SQ4431EY-T1-GE3	SQ4431EY-T1_GE3
SQ4435EY	SQ4435EY-T1-GE3	SQ4435EY-T1_GE3
SQ4470EY	SQ4470EY-T1-GE3	SQ4470EY-T1_GE3
SQ4483BEEY	SQ4483BEEY-T1-GE3	SQ4483BEEY-T1_GE3
SQ4483EY	-	SQ4483EY-T1_GE3
SQ4532AEY	-	SQ4532AEY-T1_GE3
SQ4840EY	SQ4840EY-T1-GE3	SQ4840EY-T1_GE3
SQ4850EY	SQ4850EY-T1-GE3	SQ4850EY-T1_GE3
SQ4917EY	SQ4917EY-T1-GE3	SQ4917EY-T1_GE3
SQ4920EY	SQ4920EY-T1-GE3	SQ4920EY-T1_GE3
SQ4937EY	SQ4937EY-T1-GE3	SQ4937EY-T1_GE3
SQ4940AEY	SQ4940AEY-T1-GE3	SQ4940AEY-T1_GE3
SQ4946AEY	SQ4946AEY-T1-GE3	SQ4946AEY-T1_GE3
SQ4949EY	SQ4949EY-T1-GE3	SQ4949EY-T1_GE3
SQ4961EY	SQ4961EY-T1-GE3	SQ4961EY-T1_GE3
SQ9407EY	SQ9407EY-T1-GE3	SQ9407EY-T1_GE3
SQ9945BEY	SQ9945BEY-T1-GE3	SQ9945BEY-T1_GE3

Note

a. Old ordering code is obsolete and no longer valid for new orders



SOIC (NARROW): 8-LEAD

JEDEC Part Number: MS-012

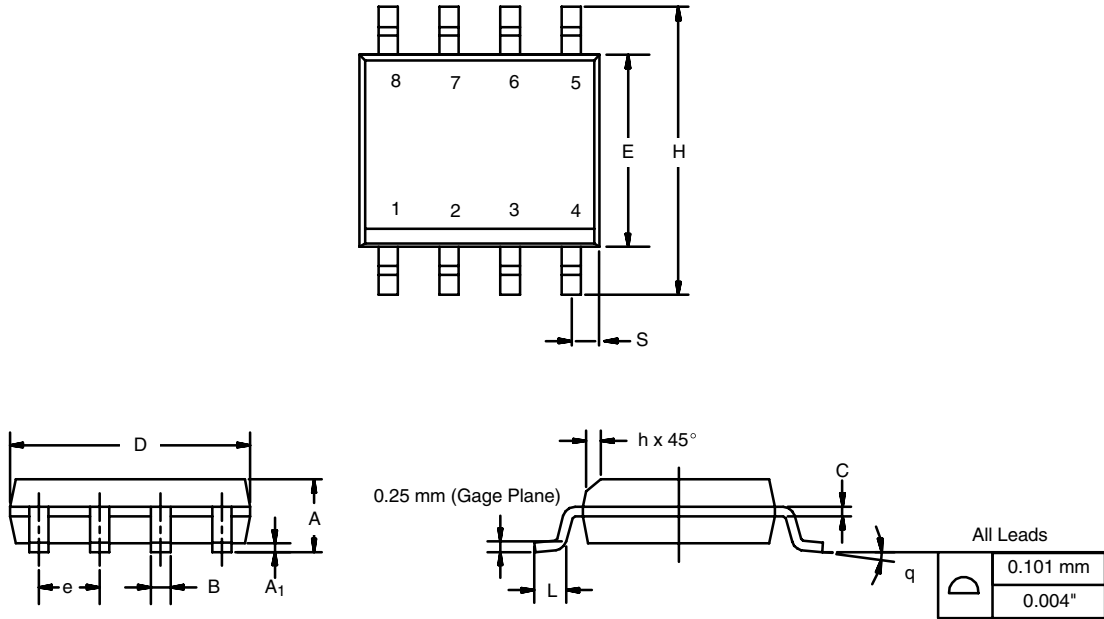

DIM	MILLIMETERS		INCHES	
	Min	Max	Min	Max
A	1.35	1.75	0.053	0.069
A ₁	0.10	0.20	0.004	0.008
B	0.35	0.51	0.014	0.020
C	0.19	0.25	0.0075	0.010
D	4.80	5.00	0.189	0.196
E	3.80	4.00	0.150	0.157
e	1.27 BSC		0.050 BSC	
H	5.80	6.20	0.228	0.244
h	0.25	0.50	0.010	0.020
L	0.50	0.93	0.020	0.037
q	0°	8°	0°	8°
S	0.44	0.64	0.018	0.026
ECN: C-06527-Rev. I, 11-Sep-06				
DWG: 5498				

RECOMMENDED MINIMUM PADS FOR SO-8



Recommended Minimum Pads
Dimensions in Inches/(mm)

[Return to Index](#)



Disclaimer

ALL PRODUCT, PRODUCT SPECIFICATIONS AND DATA ARE SUBJECT TO CHANGE WITHOUT NOTICE TO IMPROVE RELIABILITY, FUNCTION OR DESIGN OR OTHERWISE.

Vishay Intertechnology, Inc., its affiliates, agents, and employees, and all persons acting on its or their behalf (collectively, "Vishay"), disclaim any and all liability for any errors, inaccuracies or incompleteness contained in any datasheet or in any other disclosure relating to any product.

Vishay makes no warranty, representation or guarantee regarding the suitability of the products for any particular purpose or the continuing production of any product. To the maximum extent permitted by applicable law, Vishay disclaims (i) any and all liability arising out of the application or use of any product, (ii) any and all liability, including without limitation special, consequential or incidental damages, and (iii) any and all implied warranties, including warranties of fitness for particular purpose, non-infringement and merchantability.

Statements regarding the suitability of products for certain types of applications are based on Vishay's knowledge of typical requirements that are often placed on Vishay products in generic applications. Such statements are not binding statements about the suitability of products for a particular application. It is the customer's responsibility to validate that a particular product with the properties described in the product specification is suitable for use in a particular application. Parameters provided in datasheets and / or specifications may vary in different applications and performance may vary over time. All operating parameters, including typical parameters, must be validated for each customer application by the customer's technical experts. Product specifications do not expand or otherwise modify Vishay's terms and conditions of purchase, including but not limited to the warranty expressed therein.

Except as expressly indicated in writing, Vishay products are not designed for use in medical, life-saving, or life-sustaining applications or for any other application in which the failure of the Vishay product could result in personal injury or death. Customers using or selling Vishay products not expressly indicated for use in such applications do so at their own risk. Please contact authorized Vishay personnel to obtain written terms and conditions regarding products designed for such applications.

No license, express or implied, by estoppel or otherwise, to any intellectual property rights is granted by this document or by any conduct of Vishay. Product names and markings noted herein may be trademarks of their respective owners.

Mouser Electronics

Authorized Distributor

Click to View Pricing, Inventory, Delivery & Lifecycle Information:

Vishay:

[SQ9945BEY-T1-GE3](#) [SQ9945BEY-T1_GE3](#)