

High Performance Schottky Rectifier, 2 x 15 A

 TO-263AB (D²PAK)

VS-30CTQ...SPbF

TO-262AA

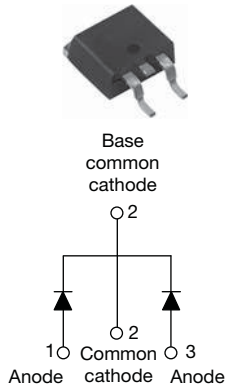
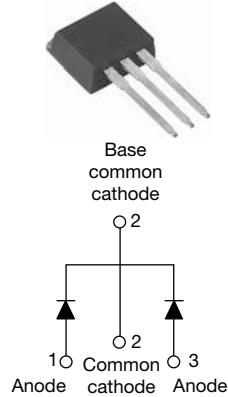

VS-30CTQ...-1PbF

FEATURES

- 175 °C T_J operation
- Center tap configuration
- Low forward voltage drop
- High frequency operation
- High purity, high temperature epoxy encapsulation for enhanced mechanical strength and moisture resistance
- Guard ring for enhanced ruggedness and long term reliability
- Meets MSL level 1, per J-STD-020, LF maximum peak of 260 °C
- AEC-Q101 qualified
- Material categorization: for definitions of compliance please see www.vishay.com/doc?99912

RoHS
 COMPLIANT
 HALOGEN
FREE

PRODUCT SUMMARY

Package	TO-263AB (D ² PAK), TO-262AA
$I_{F(AV)}$	2 x 15 A
V_R	80 V to 100 V
V_F at I_F	0.67 V
I_{RM}	7 mA at 125 °C
T_J max.	175 °C
Diode variation	Common cathode
E_{AS}	7.5 mJ

DESCRIPTION

This center tap Schottky rectifier series has been optimized for low reverse leakage at high temperature. The proprietary barrier technology allows for reliable operation up to 175 °C junction temperature. Typical applications are in switching power supplies, converters, freewheeling diodes, and reverse battery protection.

MAJOR RATINGS AND CHARACTERISTICS

SYMBOL	CHARACTERISTICS	VALUES	UNITS
$I_{F(AV)}$	Rectangular waveform	30	A
V_{RRM}		80/100	V
I_{FSM}	$t_p = 5 \mu s$ sine	850	A
V_F	15 A _{pk} , $T_J = 125 \text{ °C}$ (per leg)	0.67	V
T_J	Range	-55 to 175	°C

VOLTAGE RATINGS

PARAMETER	SYMBOL	VS-30CTQ080SPbF VS-30CTQ080-1PbF	VS-30CTQ100SPbF VS-30CTQ100-1PbF	UNITS
Maximum DC reverse voltage	V_R	80	100	V
Maximum working peak reverse voltage	V_{RWM}			

ABSOLUTE MAXIMUM RATINGS

PARAMETER	SYMBOL	TEST CONDITIONS	VALUES	UNITS
Maximum average forward current, see fig. 5	$I_{F(AV)}$	50 % duty cycle at $T_C = 129 \text{ °C}$, rectangular waveform	30	A
			15	
Maximum peak one cycle non-repetitive surge current per leg, see fig. 7	I_{FSM}	5 μs sine or 3 μs rect. pulse	850	A
		10 ms sine or 6 ms rect. pulse	275	
Non-repetitive avalanche energy per leg	E_{AS}	$T_J = 25 \text{ °C}$, $I_{AS} = 0.50 \text{ A}$, $L = 60 \text{ mH}$	7.50	mJ
Repetitive avalanche current per leg	I_{AR}	Current decaying linearly to zero in 1 μs Frequency limited by T_J maximum $V_A = 1.5 \times V_R$ typical	0.50	A



ELECTRICAL SPECIFICATIONS					
PARAMETER	SYMBOL	TEST CONDITIONS		VALUES	UNITS
Maximum forward voltage drop per leg See fig. 1	$V_{FM}^{(1)}$	15 A	$T_J = 25\text{ }^\circ\text{C}$	0.86	V
		30 A		1.05	
		15 A	$T_J = 125\text{ }^\circ\text{C}$	0.67	
		30 A		0.82	
Maximum reverse leakage current per leg See fig. 2	$I_{RM}^{(1)}$	$T_J = 25\text{ }^\circ\text{C}$	$V_R = \text{Rated } V_R$	0.55	mA
		$T_J = 125\text{ }^\circ\text{C}$		7.0	
Maximum junction capacitance per leg	C_T	$V_R = 5 V_{DC}$ (test signal range 100 kHz to 1 MHz), $25\text{ }^\circ\text{C}$		500	pF
Typical series inductance per leg	L_S	Measured lead to lead 5 mm from package body		8.0	nH
Maximum voltage rate of change	dV/dt	Rated V_R		10 000	V/ μ s

Note(1) Pulse width < 300 μ s, duty cycle < 2 %

THERMAL - MECHANICAL SPECIFICATIONS					
PARAMETER	SYMBOL	TEST CONDITIONS		VALUES	UNITS
Maximum junction and storage temperature range	T_J, T_{Stg}			-55 to +175	$^\circ\text{C}$
Maximum thermal resistance, junction to case per leg	R_{thJC}	DC operation		3.25	$^\circ\text{C}/\text{W}$
Maximum thermal resistance, junction to case per package				1.63	
Typical thermal resistance, case to heatsink	R_{thCS}	Mounting surface, smooth and greased		0.50	
Approximate weight			2		g
			0.07		oz.
Mounting torque	minimum			6 (5)	kgf · cm (lbf · in)
	maximum			12 (10)	
Marking device			Case style TO-263AB (D ² PAK)		30CTQ100S
			Case style TO-262AA		30CTQ100-1

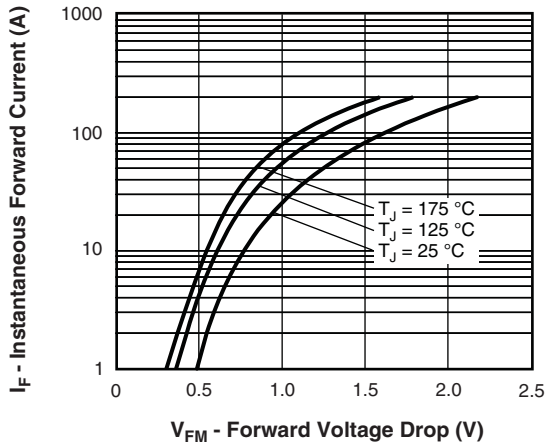

Fig. 1 - Maximum Forward Voltage Drop Characteristics (Per Leg)

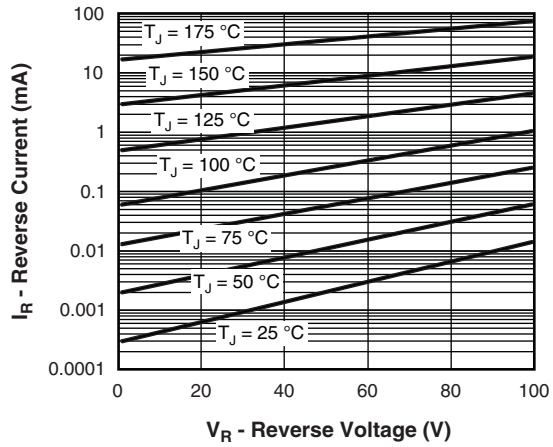

Fig. 2 - Typical Values of Reverse Current vs. Reverse Voltage (Per Leg)

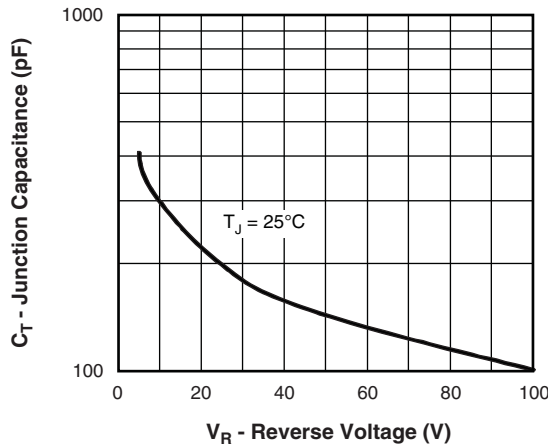

Fig. 3 - Typical Junction Capacitance vs. Reverse Voltage (Per Leg)

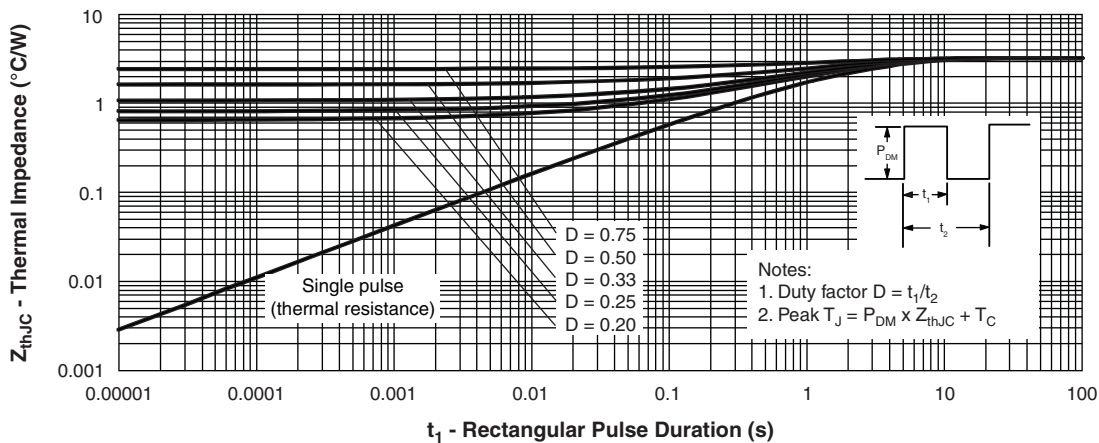

Fig. 4 - Maximum Thermal Impedance Z_{thJC} Characteristics (Per Leg)

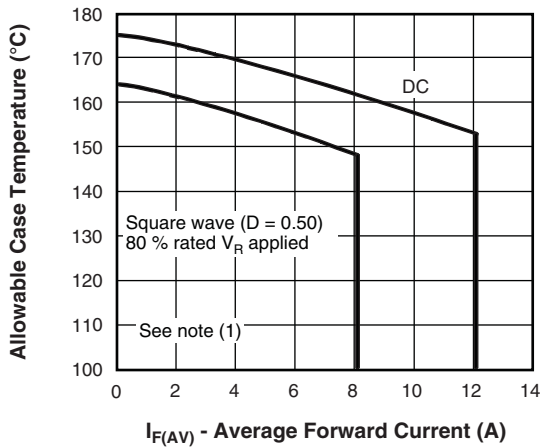

Fig. 5 - Maximum Allowable Case Temperature vs. Average Forward Current (Per Leg)

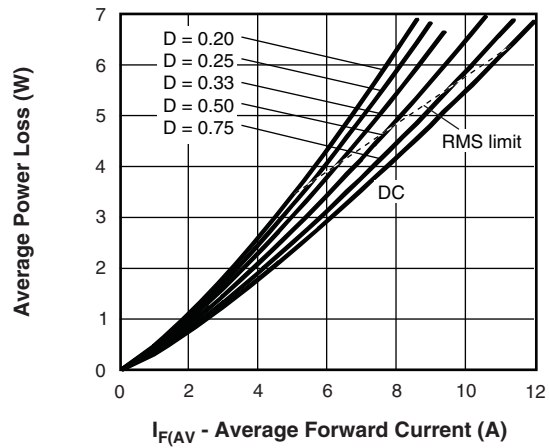

Fig. 6 - Forward Power Loss Characteristics (Per Leg)

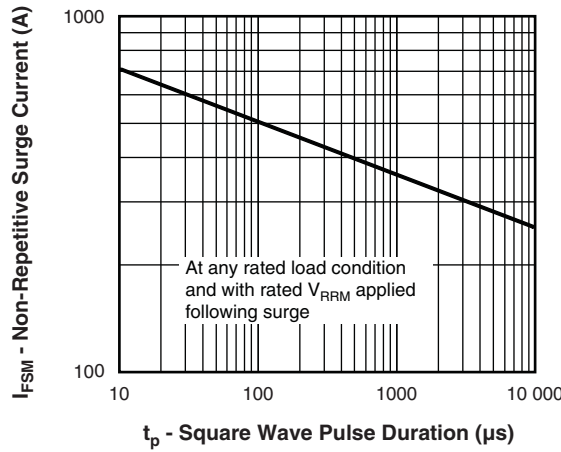

Fig. 7 - Maximum Non-Repetitive Surge Current (Per Leg)

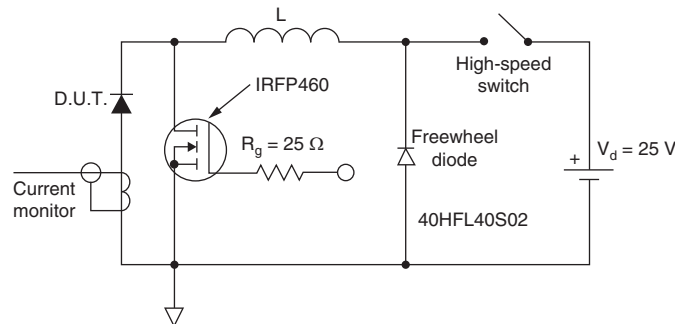

Fig. 8 - Unclamped Inductive Test Circuit

Note

- (1) Formula used: $T_C = T_J - (P_d + P_{d_{REV}}) \times R_{thJC}$;
- P_d = Forward power loss = $I_{F(AV)} \times V_{FM}$ at $(I_{F(AV)}/D)$ (see fig. 6);
- $P_{d_{REV}}$ = Inverse power loss = $V_{R1} \times I_R (1 - D)$; I_R at $V_{R1} = 10 V$



ORDERING INFORMATION TABLE

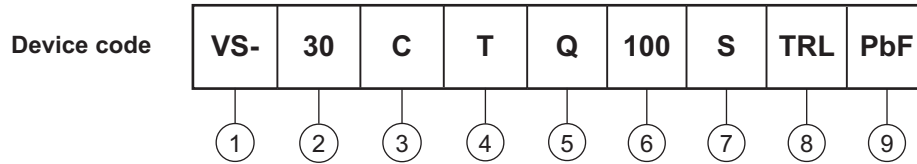

- 1** - Vishay Semiconductors product
- 2** - Current rating (30 A)
- 3** - Circuit configuration: C = common cathode
- 4** - T = TO-220
- 5** - Schottky "Q" series
- 6** - Voltage ratings

080 = 80 V
100 = 100 V
- 7** -
 - S = D²PAK
 - -1 = TO-262
- 8** -
 - None = tube (50 pieces)
 - TRL = tape and reel (left oriented - for D²PAK only)
 - TRR = tape and reel (right oriented - for D²PAK only)
- 9** - PbF = lead (Pb)-free

ORDERING INFORMATION (Example)			
PREFERRED P/N	QUANTITY PER REEL	MINIMUM ORDER QUANTITY	PACKAGING DESCRIPTION
VS-30CTQ080SPBF	50	1000	Antistatic plastic tubes
VS-30CTQ080STRRPBF	800	800	13" diameter plastic tape and reel
VS-30CTQ080STRLPBF	800	800	13" diameter plastic tape and reel
VS-30CTQ080-1PBF	50	1000	Antistatic plastic tubes
VS-30CTQ090SPBF	50	1000	Antistatic plastic tubes
VS-30CTQ090STRRPBF	800	800	13" diameter plastic tape and reel
VS-30CTQ090STRLPBF	800	800	13" diameter plastic tape and reel
VS-30CTQ090-1PBF	50	1000	Antistatic plastic tubes
VS-30CTQ100SPBF	50	1000	Antistatic plastic tubes
VS-30CTQ100STRRPBF	800	800	13" diameter plastic tape and reel
VS-30CTQ100STRLPBF	800	800	13" diameter plastic tape and reel
VS-30CTQ100-1PBF	50	1000	Antistatic plastic tubes

LINKS TO RELATED DOCUMENTS		
Dimensions	TO-263AB (D ² PAK)	www.vishay.com/doc?95046
	TO-262AA	www.vishay.com/doc?95419
Part marking information		www.vishay.com/doc?95008
Packaging information		www.vishay.com/doc?95032

D²PAK, TO-262

DIMENSIONS FOR D²PAK in millimeters and inches

Conforms to JEDEC outline D²PAK (SMD-220)



SYMBOL	MILLIMETERS		INCHES		NOTES
	MIN.	MAX.	MIN.	MAX.	
A	4.06	4.83	0.160	0.190	
A1	0.00	0.254	0.000	0.010	
b	0.51	0.99	0.020	0.039	
b1	0.51	0.89	0.020	0.035	4
b2	1.14	1.78	0.045	0.070	
b3	1.14	1.73	0.045	0.068	4
c	0.38	0.74	0.015	0.029	
c1	0.38	0.58	0.015	0.023	4
c2	1.14	1.65	0.045	0.065	
D	8.51	9.65	0.335	0.380	2

SYMBOL	MILLIMETERS		INCHES		NOTES
	MIN.	MAX.	MIN.	MAX.	
D1	6.86	8.00	0.270	0.315	3
E	9.65	10.67	0.380	0.420	2, 3
E1	7.90	8.80	0.311	0.346	3
e	2.54 BSC		0.100 BSC		
H	14.61	15.88	0.575	0.625	
L	1.78	2.79	0.070	0.110	
L1	-	1.65	-	0.066	3
L2	1.27	1.78	0.050	0.070	
L3	0.25 BSC		0.010 BSC		
L4	4.78	5.28	0.188	0.208	

Notes

- (1) Dimensioning and tolerancing per ASME Y14.5 M-1994
- (2) Dimension D and E do not include mold flash. Mold flash shall not exceed 0.127 mm (0.005") per side. These dimensions are measured at the outmost extremes of the plastic body
- (3) Thermal pad contour optional within dimension E, L1, D1 and E1
- (4) Dimension b1 and c1 apply to base metal only
- (5) Datum A and B to be determined at datum plane H
- (6) Controlling dimension: inch

- (7) Outline conforms to JEDEC outline TO-263AB

DIMENSIONS FOR TO-262 in millimeters and inches



SYMBOL	MILLIMETERS		INCHES		NOTES
	MIN.	MAX.	MIN.	MAX.	
A	4.06	4.83	0.160	0.190	
A1	2.03	3.02	0.080	0.119	
b	0.51	0.99	0.020	0.039	
b1	0.51	0.89	0.020	0.035	4
b2	1.14	1.78	0.045	0.070	
b3	1.14	1.73	0.045	0.068	4
c	0.38	0.74	0.015	0.029	
c1	0.38	0.58	0.015	0.023	4
c2	1.14	1.65	0.045	0.065	
D	8.51	9.65	0.335	0.380	2
D1	6.86	8.00	0.270	0.315	3
E	9.65	10.67	0.380	0.420	2, 3
E1	7.90	8.80	0.311	0.346	3
e	2.54 BSC		0.100 BSC		
L	13.46	14.10	0.530	0.555	
L1	-	1.65	-	0.065	3
L2	3.56	3.71	0.140	0.146	

Notes

- (1) Dimensioning and tolerancing as per ASME Y14.5M-1994
- (2) Dimension D and E do not include mold flash. Mold flash shall not exceed 0.127 mm (0.005") per side. These dimensions are measured at the outmost extremes of the plastic body
- (3) Thermal pad contour optional within dimension E, L1, D1 and E1
- (4) Dimension b1 and c1 apply to base metal only
- (5) Controlling dimension: inches
- (6) Outline conform to JEDEC TO-262 except A1 (maximum), b (minimum) and D1 (minimum) where dimensions derived the actual package outline



Disclaimer

ALL PRODUCT, PRODUCT SPECIFICATIONS AND DATA ARE SUBJECT TO CHANGE WITHOUT NOTICE TO IMPROVE RELIABILITY, FUNCTION OR DESIGN OR OTHERWISE.

Vishay Intertechnology, Inc., its affiliates, agents, and employees, and all persons acting on its or their behalf (collectively, "Vishay"), disclaim any and all liability for any errors, inaccuracies or incompleteness contained in any datasheet or in any other disclosure relating to any product.

Vishay makes no warranty, representation or guarantee regarding the suitability of the products for any particular purpose or the continuing production of any product. To the maximum extent permitted by applicable law, Vishay disclaims (i) any and all liability arising out of the application or use of any product, (ii) any and all liability, including without limitation special, consequential or incidental damages, and (iii) any and all implied warranties, including warranties of fitness for particular purpose, non-infringement and merchantability.

Statements regarding the suitability of products for certain types of applications are based on Vishay's knowledge of typical requirements that are often placed on Vishay products in generic applications. Such statements are not binding statements about the suitability of products for a particular application. It is the customer's responsibility to validate that a particular product with the properties described in the product specification is suitable for use in a particular application. Parameters provided in datasheets and / or specifications may vary in different applications and performance may vary over time. All operating parameters, including typical parameters, must be validated for each customer application by the customer's technical experts. Product specifications do not expand or otherwise modify Vishay's terms and conditions of purchase, including but not limited to the warranty expressed therein.

Except as expressly indicated in writing, Vishay products are not designed for use in medical, life-saving, or life-sustaining applications or for any other application in which the failure of the Vishay product could result in personal injury or death. Customers using or selling Vishay products not expressly indicated for use in such applications do so at their own risk. Please contact authorized Vishay personnel to obtain written terms and conditions regarding products designed for such applications.

No license, express or implied, by estoppel or otherwise, to any intellectual property rights is granted by this document or by any conduct of Vishay. Product names and markings noted herein may be trademarks of their respective owners.

Mouser Electronics

Authorized Distributor

Click to View Pricing, Inventory, Delivery & Lifecycle Information:

[Vishay:](#)

[VS-30CTQ100STRLPBF](#) [VS-30CTQ080STRLPBF](#) [VS-30CTQ100STRRPBF](#) [VS-30CTQ060STRRPBF](#) [VS-30CTQ060-1PBF](#) [VS-30CTQ080-1PBF](#) [VS-30CTQ080SPBF](#) [VS-30CTQ100-1PBF](#) [30CTQ080-1](#) [30CTQ080GS](#) [30CTQ080GSTRL](#) [30CTQ080GSTRR](#) [30CTQ080STRL](#) [30CTQ080STRR](#) [30CTQ100-1](#) [30CTQ100GS](#) [30CTQ100GSTRL](#) [30CTQ100GSTRR](#) [30CTQ100S](#) [30CTQ100STRL](#) [30CTQ100STRR](#) [VS-30CTQ060STRLPBF](#) [VS-30CTQ080STRRPBF](#)